

ML-330x Series
ML-331x Series
ML-371x Series

User's Guide

Basic

imagine the possibilities

This guide provides information concerning installation, basic operation and troubleshooting on windows.



1. Introduction

- 5 Key benefits
- 7 Features by models
- 8 Useful to know
- 9 About this user's guide
- 10 Safety information
- 16 Machine overview
- 19 Control panel overview
- 22 Turning on the machine
- 23 Installing the driver locally
- 24 Reinstalling the driver



2. Menu overview and basic setup

- 28 Menu overview
- 30 Printing a demo page
- 31 Changing the display language
- 32 Media and tray
- 43 Basic printing



3. Maintenance

- 50 Ordering supplies and accessories
- 51 Available supplies
- 52 Available accessories
- 53 Available maintenance parts
- 54 Redistributing toner
- 56 Replacing the toner cartridge
- 58 Upgrading a memory module
- 60 Monitoring the supplies life
- 61 Setting the toner low alert
- 62 Cleaning the machine



4. Troubleshooting

- 67 Tips for avoiding paper jams
- 68 Clearing paper jams
- 74 Understanding the status LED
- 77 Understanding display messages



5. Appendix

- 83 Specifications

93 Regulatory information

104 Copyright



1. Introduction

This chapter provides information you need to know before using the machine.

- **Key benefits** 5
- **Features by models** 7
- **Useful to know** 8
- **About this user's guide** 9
- **Safety information** 10
- **Machine overview** 16
- **Control panel overview** 19
- **Turning on the machine** 22
- **Installing the driver locally** 23
- **Reinstalling the driver** 24

Key benefits

Environmentally friendly



- To save toner and paper, this machine supports Eco feature.
- To save paper, you can print multiple pages on one single sheet of paper (see Advanced Guide).
- To save paper, you can print on both sides of the paper (double-sided printing) (see Advanced Guide).
- To save electricity, this machine automatically conserves electricity by substantially reducing power consumption when not in use.

Print with excellent quality and speed



- You can print with a resolution of up to 1,200 x 1,200 dpi effective output.
- Fast, on-demand printing.
ML-330x:
 - For single-side printing, 31 ppm (A4) or 33 ppm (Letter).ML-331xD/ ML-331xND:
 - For single-side printing, 31 ppm (A4) or 33 ppm (Letter).

- For duplex printing, 15 ppm (A4) or 16 ppm (Letter).
ML-371xD/ ML-371xND/ ML-371xDW:
- For single-side printing, 35 ppm (A4) or 37 ppm (Letter).
- For duplex printing, 17 ppm (A4) or 18 ppm (Letter).

Convenience



- Samsung Easy Printer Manager and Samsung Printer Status (or Smart Panel) are a program that monitors and informs you of the machine's status and allows you to customize the machine's settings (see Advanced Guide).
- AnyWeb Print helps you screen-capture, preview, scrap, and print the screen of Windows Internet Explorer more easily, than when you use the ordinary program (see Advanced Guide).

Key benefits

Wide range of functionality and application support



- Supports various paper sizes (see "Print media specifications" on page 85).
- Print watermark: You can customize your documents with words, such as "Confidential" (see Advanced Guide).
- Print posters: The text and pictures of each page of your document are magnified and printed across the multiple sheets of paper and can then be taped together to form a poster (see Advanced Guide).
- You can print in various operating systems (see "System requirements" on page 88).
- Your machine is equipped with a USB interface and/or a network interface.

Expand your machine's capacity

- This machine has an extra memory slot for adding more memory (see "Available accessories" on page 52).
- ML-371xD/ ML-371xND/ ML-371xDW: Emulation compatible with PostScript 3 (PS3) enables PS printing.

Features by models

Some features and optional goods may not be available depending on model or country.

Features	ML-331xD	ML-331xND	ML-371xD	ML-371xND	ML-371xDW
Hi-Speed USB 2.0	●	●	●	●	●
IEEE 1284 parallel connector	○	○	○	○	○
Network Interface Ethernet 10/100 Base TX wired LAN		●			
Network Interface Ethernet 10/100/1000 Base TX wired LAN				●	●
Network Interface 802.11b/g/n wireless LAN					●
IPv6		●		●	●
Eco printing	●	●	●	●	●
Wi-Fi Protected Setup™ (WPS)					●
Duplex (2-sided) printing	●	●	●	●	●
Samsung Easy Printer Manager	●	●	●	●	●
Memory			○	○	○
Tray 2 (520 sheets)		○	○	○	○
SyncThru™ Web Service		●		●	●

(●: Included, ○: Optional, Blank: Not available)

Useful to know



The machine does not print.

- Open the print queue list and remove the document from the list (see "Canceling a print job" on page 44).
- Remove the driver and install it again (see "Installing the driver locally" on page 23).
- Select your machine as your default machine in your Windows.



Where can I purchase accessories or supplies?

- Inquire at a Samsung distributor or your retailer.
- Visit www.samsung.com/supplies. Select your country/region to view product service information.



The status LED flashes or remains constantly on.

- Turn the product off and on again.
- Check the meanings of LED indications in this manual and troubleshoot accordingly (see "Understanding the status LED" on page 74).



A paper jam has occurred.

- Open and close the front door.
- Check the instructions on removing jammed paper in this manual and troubleshoot accordingly (see "Clearing paper jams" on page 68).



Printouts are blurry.

- The toner level might be low or uneven. Shake the toner cartridge.
- Try a different print resolution setting.
- Replace the toner cartridge.



Where can I download the machine's driver?

- Visit www.samsung.com/printer to download the latest machine's driver, and install it on your system.

This user's guide provides information for your basic understanding of the machine as well as detailed steps to explain machine usage.

- Read the safety information before using the machine.
- If you have a problem using the machine, refer to the troubleshooting chapter.
- Terms used in this user's guide are explained in the glossary chapter.
- All illustrations in this user's guide may differ from your machine depending on its options or model you purchased.
- The screenshots in this user's guide may differ from your machine depending on the machine's firmware/driver version.
- The procedures in this user's guide are mainly based on Windows 7.



Conventions

Some terms in this guide are used interchangeably, as below:

- Document is synonymous with original.
- Paper is synonymous with media, or print media.
- Machine refers to printer or MFP.



General icons

Icon	Text	Description
A green square icon with a white exclamation mark.	Caution	Gives users information to protect the machine from possible mechanical damage or malfunction.
A blue icon of a document with a checkmark.	Note	Provides additional information or detailed specification of the machine function and feature.

These warnings and precautions are included to prevent injury to you and others, and to prevent any potential damage to your machine. Be sure to read and understand all of these instructions before using the machine. After reading this section, keep it in a safe place for future reference.



Important safety symbols

Explanation of all icons and signs used in this chapter

	Warning	Hazards or unsafe practices that may result in severe personal injury or death.
	Caution	Hazards or unsafe practices that may result in minor personal injury or property damage.
	Do not attempt.	



Operating environment



Warning



Do not use if the power cord is damaged or if the electrical outlet is not grounded.

This could result in electric shock or fire.



Do not place anything on top of the machine (water, small metal or heavy objects, candles, lit cigarettes, etc.).

This could result in electric shock or fire.

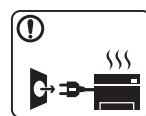

- If the machine gets overheated, it releases smoke, makes strange noises, or generates an odd odor, immediately turn off the power switch and unplug the machine.

- The user should be able to access the power outlet in case of emergencies that might require the user to pull the plug out.

This could result in electric shock or fire.



Do not bend, or place heavy objects on the power cord.

Stepping on or allowing the power cord to be crushed by a heavy object could result in electric shock or fire.



Do not remove the plug by pulling on the cord; do not handle the plug with wet hands.

This could result in electric shock or fire.

Caution

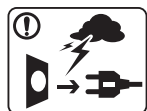

During an electrical storm or for a period of non-operation, remove the power plug from the electrical outlet.

This could result in electric shock or fire.



Be careful, the paper output area is hot.

Burns could occur.



If the machine has been dropped, or if the cabinet appears damaged, unplug the machine from all interface connections and request assistance from qualified service personnel.

Otherwise, this could result in electric shock or fire.



If the plug does not easily enter the electrical outlet, do not attempt to force it in.

Call an electrician to change the electrical outlet, or this could result in electric shock.



Do not allow pets to chew on the AC power, telephone or PC interface cords.

This could result in electric shock or fire and/or injury to your pet.



If the machine does not operate properly after these instructions have been followed, unplug the machine from all interface connections and request assistance from qualified service personnel.

Otherwise, this could result in electric shock or fire.



Operating method





Caution



Do not forcefully pull the paper out during printing. It can cause damage to the machine.

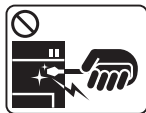

Be careful not to put your hand between the machine and paper tray. You may get injured.

	<p>Do not block or push objects into the ventilation opening.</p> <p>This could result in elevated component temperatures which can cause damage or fire.</p>
	<p>Be care when replacing paper or removing jammed paper.</p> <p>New paper has sharp edges and can cause painful cuts.</p>
	<p>When printing large quantities, the bottom part of the paper output area may get hot. Do not allow children to touch.</p> <p>Burns can occur.</p>
	<p>When removing jammed paper, do not use tweezers or sharp metal objects.</p> <p>It can damage the machine.</p>
	<p>Do not allow too many papers to stack up in the paper output tray.</p> <p>It can damage the machine.</p>
	<p>This machine's power reception device is the power cord.</p> <p>To switch off the power supply, remove the power cord from the electrical outlet.</p>



Installation / Moving



Warning



Do not place the machine in an area with dust, humidity, or water leaks.

This could result in electric shock or fire.



Caution









Before moving the machine, turn the power off and disconnect all cords.

Then lift the machine:

- If the machine weighs under 20 kg (44.09 lbs), lift with 1 person.
- If the machine weighs 20 kg (44.09 lbs) - 40kg (88.18 lbs), lift with 2 people.
- If the machine weighs more than 40 kg (88.18 lbs), lift with 4 or more people.

The machine could fall, causing injury or machine damage.

	Do not place the machine on an unstable surface. The machine could fall, causing injury or machine damage.
	The machine should be connected to the power level which is specified on the label. If you are unsure and want to check the power level you are using, contact the electrical utility company.
	Use only No.26 AWG ^a or larger, telephone line cord, if necessary. Otherwise, it can cause damage to the machine.
	Do not put a cover over the machine or place it in an airtight location, such as a closet. If the machine is not well-ventilated, this could result in fire.
	Make sure you plug the power cord into a grounded electrical outlet. Otherwise, this could result in electric shock or fire.
	Do not overload wall outlets and extension cords. This can diminish performance, and could result in electric shock or fire.

	Use the power cord supplied with your machine for safe operation. If you are using a cord which is longer than 2 meters (6 feet) with a 110 V machine, then the gauge should be 16 AWG or larger. Otherwise, it can cause damage to the machine, and could result in electric shock or fire.
---	---



a. AWG: American Wire Gauge







Maintenance / Checking



Caution

	Unplug this product from the wall outlet before cleaning the inside of the machine. Do not clean the machine with benzene, paint thinner or alcohol; do not spray water directly into the machine. This could result in electric shock or fire.
	When you are working inside the machine replacing supplies or cleaning the inside, do not operate the machine. You could get injured.





	<p>Keep the power cable and the contact surface of the plug clean from dust or water.</p> <p>Otherwise, this could result in electric shock or fire.</p>
	<ul style="list-style-type: none">Do not remove any covers or guards that are fastened with screws.Fuser units should only be repaired by a certified service technician. Repair by non-certified technicians could result in fire or electric shock. <p>The machine should only be repaired by a Samsung service technician.</p>
	<p>Keep cleaning supplies away from children.</p> <p>Children could get hurt.</p>
	<p>Do not disassemble, repair or rebuild the machine by yourself.</p> <p>It can damage the machine. Call a certified technician when the machine needs repairing.</p>
	<p>To clean and operate the machine, strictly follow the user's guide provided with the machine.</p> <p>Otherwise, you could damage the machine.</p>



Supply usage



Caution

	<p>Do not disassemble the toner cartridge.</p> <p>Toner dust can be dangerous if inhaled or ingested.</p>
	<p>Do not burn any of the supplies such as toner cartridge or fuser unit.</p> <p>This could cause an explosion or uncontrollable fire.</p>
	<p>When changing the toner cartridge or removing jammed paper, be careful not to let toner dust touch your body or clothes.</p> <p>Toner dust can be dangerous if inhaled or ingested.</p>
	<p>When storing supplies such as toner cartridges, keep them away from children.</p> <p>Toner dust can be dangerous if inhaled or ingested.</p>
	<p>Using recycled supplies, such as toner, can cause damage to the machine.</p> <p>In case of damage due to the use of recycled supplies, a service fee will be charged.</p>



When toner gets on your clothing, do not use hot water to wash it.

Hot water sets toner into fabric. Use cold water.



Accessories



Power cord



Quick installation guide

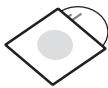

Software CD^a

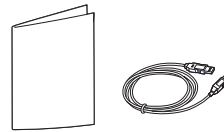

Misc. accessories^b

a. The software CD contains the printer driver and applications.

b. Miscellaneous accessories included with your machine may vary by country of purchase and specific model.



Front view



- This illustration may differ from your machine depending on its model.
- Some features and optional goods may not be available depending on model or country.

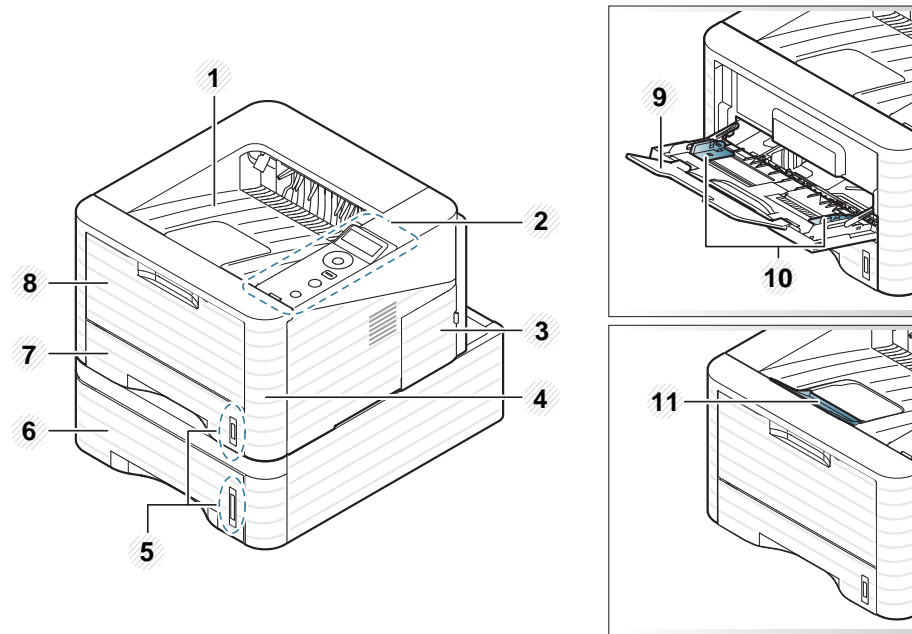

1	Output tray	4	Front cover	7	Tray 1	10	Paper width guides on a multi-purpose tray
2	Control panel	5	Paper level indicator	8	Multi-purpose tray	11	Output support
3	Control board cover	6	Tray 2	9	Multi-purpose tray paper extension		



Rear view



- This illustration may differ from your machine depending on its model.
- Some features and optional goods may not be available depending on model or country.

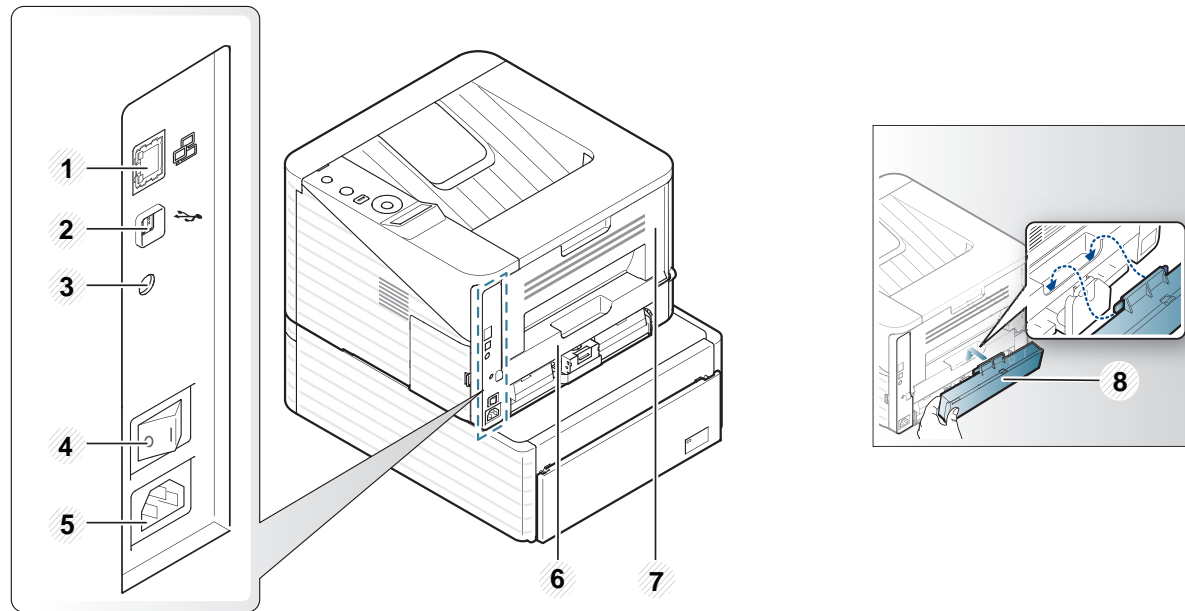

1	Network port	3	IEEE 1284 parallel connector	5	Power receptacle	7	Rear cover
2	USB port	4	Power-switch	6	Duplex unit	8	Tray back cover



This control panel may differ from your machine depending on its model. There are various types of control panels.



Type A

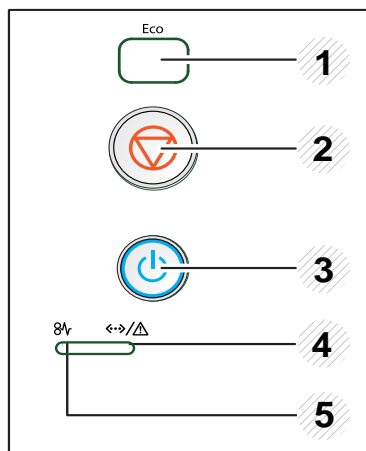

1

Eco

Enters eco mode to reduce toner consumption and paper usage (see "Eco options" on page 47).

2



Stops an operation at any time and there are more functions.

- **Cancels the current job.**
- **Prints demo page:** Press and hold this button for about 5 seconds until the status LED blinks, and release.
- **Prints configuration reports:** Press and hold this button for about 3 seconds until the status LED blinks, and release.

3



You can turn the power on and off with this button.

4

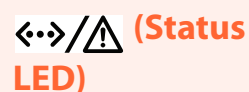

Shows the status of your machine (see "Status LED" on page 75).

5



Shows the jam occurrence status of your machine (see "Clearing paper jams" on page 68).



Type B

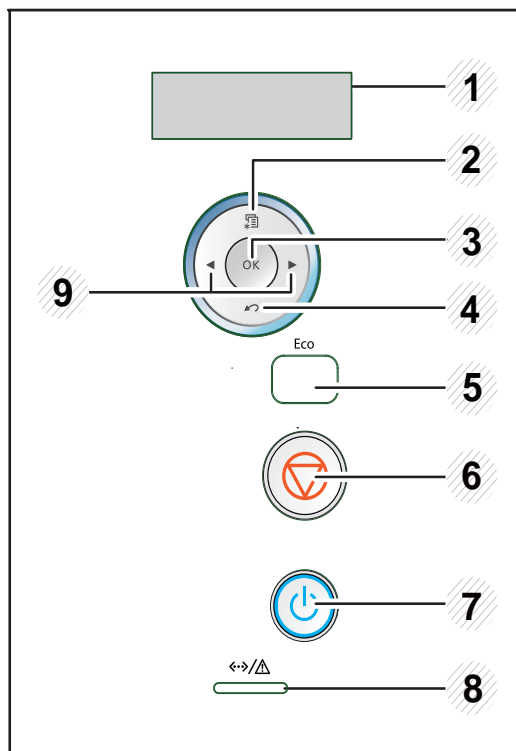

1	Display	Shows the current status and prompts during an operation.
2	(Menu)	Enters menu mode and scrolls through the available menus.
3	OK	Confirms the selection on the display.

4	(Back)	Sends you back to the upper menu level.
5	Eco	Enters eco mode to reduce toner consumption and paper usage (see "Eco options" on page 47).
6	(Cancel)	Stops an operation at any time.
7	(Power)	You can turn the power on and off with this button.
8	(Status LED)	Shows the status of your machine (see "Status LED" on page 75).
9	Arrows	Navigates available values by moving to the next or previous options.



Type C

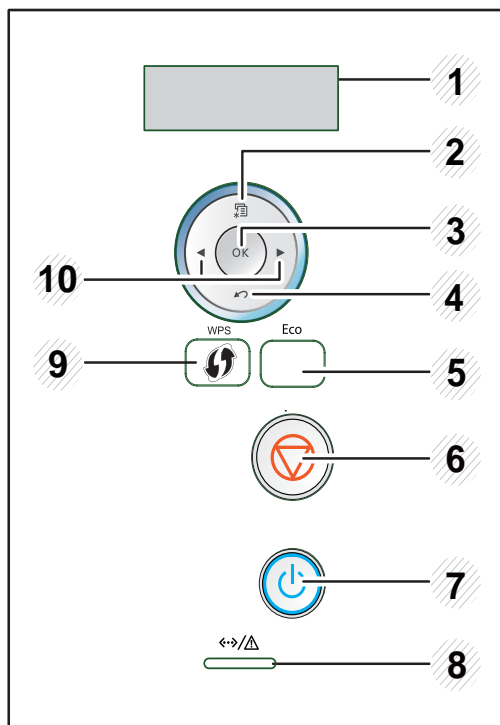

1	Display	Shows the current status and prompts during an operation.
2	(Menu)	Enters menu mode and scrolls through the available menus.
3	OK	Confirms the selection on the display.
4	(Back)	Sends you back to the upper menu level.

5	Eco	Enters eco mode to reduce toner consumption and paper usage (see "Eco options" on page 47).
6	(Cancel)	Stops an operation at any time.
7	(Power)	You can turn the power on and off with this button.
8	(Status LED)	Shows the status of your machine (see "Status LED" on page 75).
9	(WPS)	If your wireless access point supports Wi-Fi Protected Setup™(WPS), you can configure the machine easily without a computer (see Advanced Guide).
10	Arrows	Navigates available values by moving to the next or previous options.

- 1 Connect the machine to the electricity supply first.
Turn the switch on if the machine has a power switch.

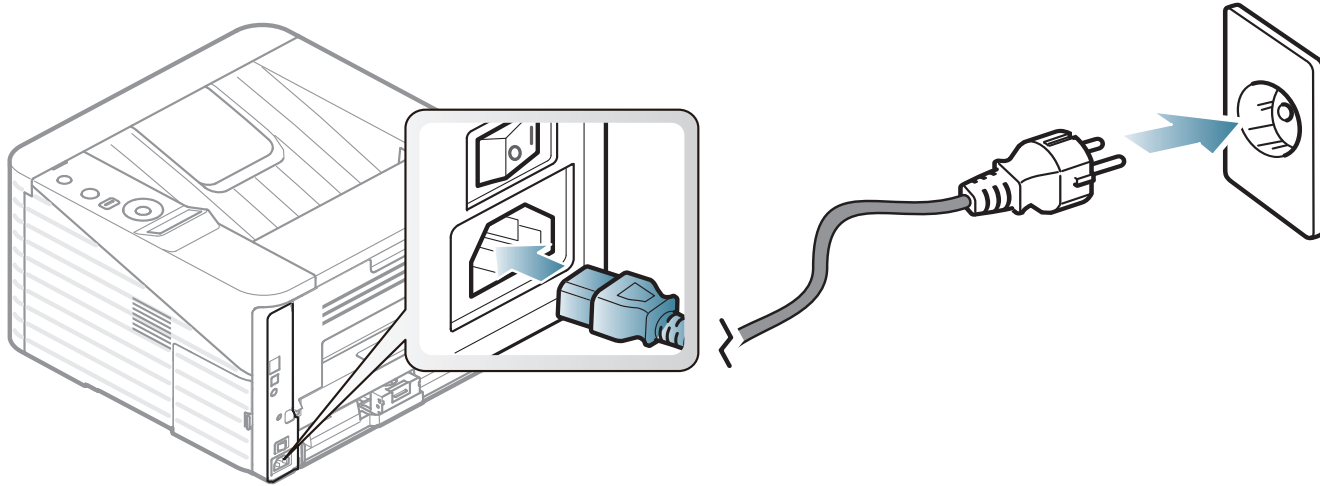

- 2 Press the  (**Power**) button, then release.

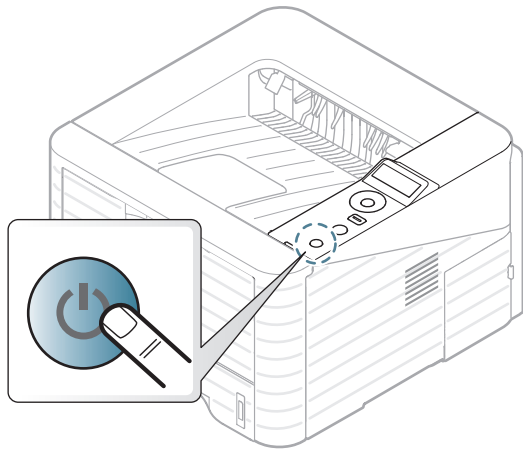

A locally connected machine is a machine directly attached to your computer using the cable. If your machine is attached to a network, skip the following steps below and go on to installing a network connected machine's driver (see Advanced Guide).



- If you are a Macintosh, Linux, or Unix OS user, refer to the Advanced guide.
- The installation window in this User's Guide may differ depending on the machine and interface in use.
- Selecting **Advanced Installation > Custom Installation** allows you to choose which programs to install.
- Only use a USB cable no longer than 3 meters (118 inches).



Windows

- 1 Make sure that the machine is connected to your computer and powered on.



If the "**Found New Hardware Wizard**" appears during the installation procedure, click **Cancel** to close the window.

- 2 Insert the supplied software CD into your CD-ROM drive.

The software CD should automatically run and an installation window will appear.

- 3 Select **Install Now**.

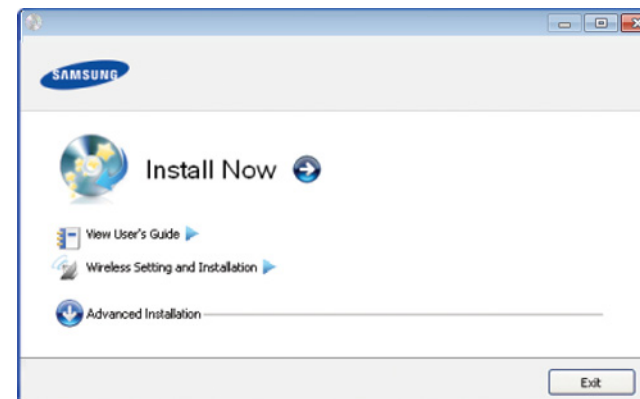

- 4 Read **License Agreement**, and select **I accept the terms of the License Agreement**. Then, click **Next**.

- 5 Follow the instructions in the installation window.

If the printer driver does not work properly, follow the steps below to reinstall the driver.



Windows

- 1** Make sure that the machine is connected to your computer and powered on.
- 2** From the **Start** menu, select **Programs** or **All Programs** > **Samsung Printers** > **your printer driver name** > **Uninstall**.
- 3** Follow the instructions in the installation window.
- 4** Insert the software CD into your CD-ROM drive and install the driver again (see "Installing the driver locally" on page 23).



2. Menu overview and basic setup

After installation is complete, you may want to set the machine's default settings. Refer to the next section if you would like to set or change values. This chapter provides information about the overall menu structure and the basic setup options.

- **Menu overview** 2
- **Printing a demo page** 4
- **Changing the display language** 5
- **Media and tray** 6
- **Basic printing** 17

The control panel provides access to various menus to set up the machine or use the machine's functions.



- These menus can be accessed by pressing  (**Menu**) button. Press the arrows until the needed menu item appears and press **OK**.
- An asterisk (*) appears next to the currently selected menu.
- Some menus may not appear on the display depending on options or models. If so, it is not applicable to your machine.
- For models that do not have the display screen on the control panel, this feature is not applicable.
- Some menu names may differ from your machine depending on its options or the models.

Items	Options
Information	Menu Map Configuration Supplies Info. Demo Page PCL Font PS Font EPSON Font Usage Counter Account Report
Layout	Orientation Common Margin MP Tray Tray X Emulation Mar. Duplex Margin
Paper	Copies MP Tray/ [Tray <x>] Paper Source Tray Chaining

Items	Options
Graphic	Resolution Darken Text
System Setup	Language Power Save Wakeup Event Altitude Adj. Auto CR Job Timeout Maintenance Toner Save Eco Setup Clear Setting
Emulation	Emulation Type Setup

Items	Options
Network	TCP/IP (IPv4) TCP/IP (IPv6) Ethernet Speed 802.1x Wireless Clear Setting Network Conf. Net. Activate Http Activate
Custom^a	
Job Management	Active Job Stored Job File Policy

a. You can start applications. You need to register the application from the SyncThru™ Web Service before you start the application.

Print a demo page to make sure that the machine is operating correctly.

- 1 Press  (**Menu**) button on the control panel.
- 2 Press **Information** > **OK** > **Demo Page** > **OK**.
- 3 Press **Print?** > **Yes** > **OK**.
A demo page prints out.



If your machine does not have a display screen, press and hold  (**Cancel**) button for about 5 seconds until the status LED blinks, and release.

To change the language that is displayed on the control panel, follow these steps:



For models that do not have the display screen on the control panel, this feature is not applicable.

- 1 Press  (**Menu**) button on the control panel.
- 2 Press **System Setup** > **OK** > **Language** > **OK**.
- 3 Press **OK** to select the language you want.

This chapter provides information on how to load print media into your machine.



- Using print media that does not meet these specifications may cause problems or require repairs. Such repairs are not covered by Samsung's warranty or service agreements.
- Make sure not to use the inkjet photo paper with this machine. It could cause damage to the machine.
- Using inflammable print media can cause a fire.
- Use designated print media (see "Print media specifications" on page 4).



The use of inflammable media or foreign materials left in the printer may lead to overheating of the unit and, in rare cases may cause a fire.



Tray overview

To change the size, you need to adjust the paper guides.

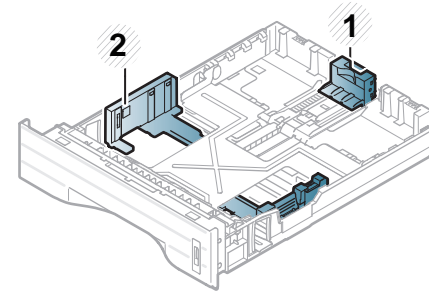

- 1 Paper length guide
- 2 Paper width guide

The duplex unit is preset to Letter/LGL or A4 size, depending on your country. To change the paper size, adjust the guide as shown below.



If you do not adjust the guide, it may cause paper registration, image skew, or jamming of the paper.

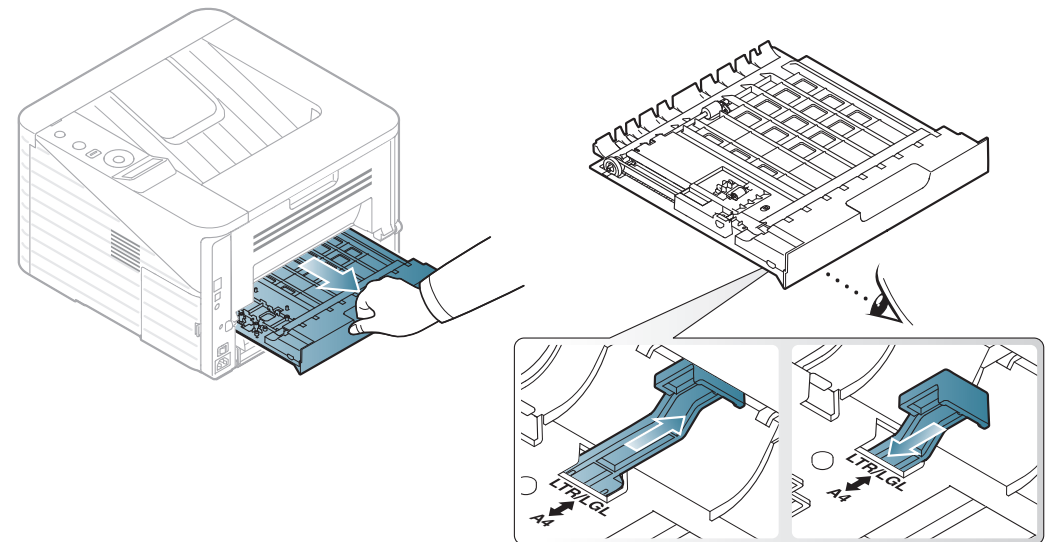



Paper quantity indicator shows the amount of paper in the tray.

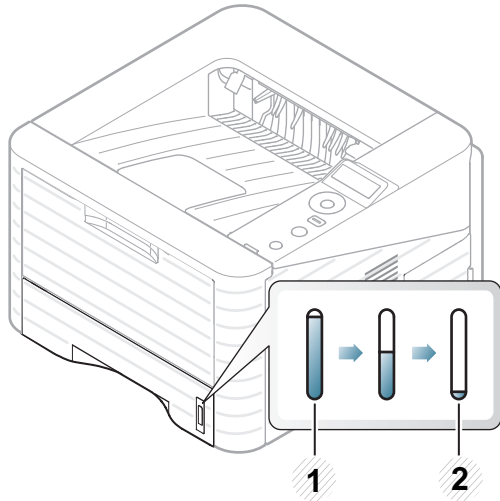

- 1 Full
- 2 Empty



Loading paper in the tray/ optional tray

- 1 Pull out the paper tray.
- 2 Flex or fan the edge of the paper stack to separate the pages before loading papers.

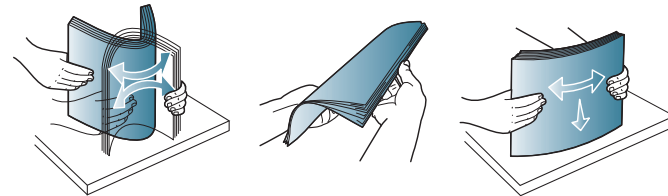

- 3 Place paper with the side you want to print on facing down.

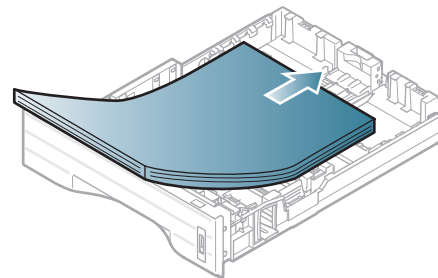

- 4** Slide the paper length guide until it lightly touches the end of the paper stack.

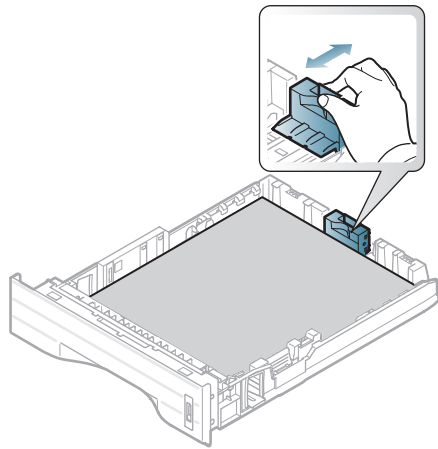

- 5** Squeeze the paper width guide and slide it to the edge of the paper stack without causing it to bend.

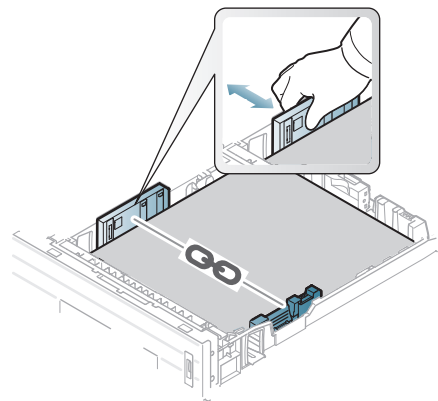

- Do not push the paper width guide too far causing the media to warp.
- If you do not adjust the paper width guide, it may cause paper jams.

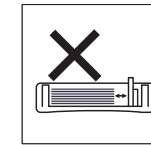
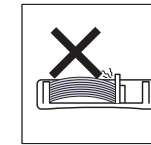
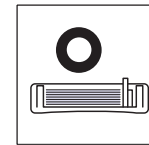

- Do not use a paper with a leading-edge curl, it may cause a paper jam or the paper can be wrinkled.

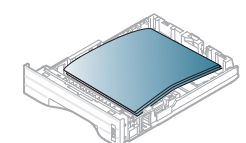
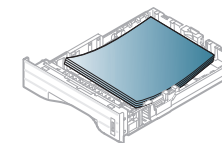
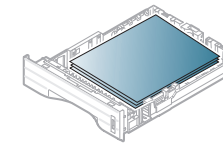

- 6** Insert the tray back into the machine.
- 7** Set the paper type and size for tray 1 (see "Setting the paper size and type" on page 16).



The settings set from the machine driver override the settings on the control panel.

- a To print from an application, open an application and start the print menu.
- b Open **Printing Preferences** (see "Opening printing preferences" on page 19).
- c Press the **Paper** tab in **Printing Preferences**, and select an appropriate paper type.



Loading in multi-purpose tray

The multi-purpose tray can hold special sizes and types of print material, such as postcards, note cards, and envelopes.

- **The machine does not have a display screen:** 1 sheet of 80 g/m² (20 lbs bond)
- **The machine has the display screen:** 50 sheets of 80 g/m² (20 lbs bond)



Tips on using the multi-purpose tray

- To prevent paper jams, do not add paper while printing when there is still paper in the multi-purpose tray.
- Print media should be loaded face up with the top edge going into the multi-purpose tray first and be placed in the center of the tray.
- To ensure printing quality and to prevent paper jams, only load the available paper (see "Print media specifications" on page 4).
- Flatten any curl on postcards, envelopes, and labels before loading them into the multi-purpose tray.
- When printing on special media, you must follow the loading guidelines (see "Printing on special media" on page 11).
- When papers overlap when printing using the multi-purpose tray, open tray 1 and remove the overlapping papers then try printing again.
- When paper does not feed well while printing, push the paper in manually until it starts feeding automatically.

- 1 Open the multi-purpose tray and unfold the multi-purpose tray extension, as shown.

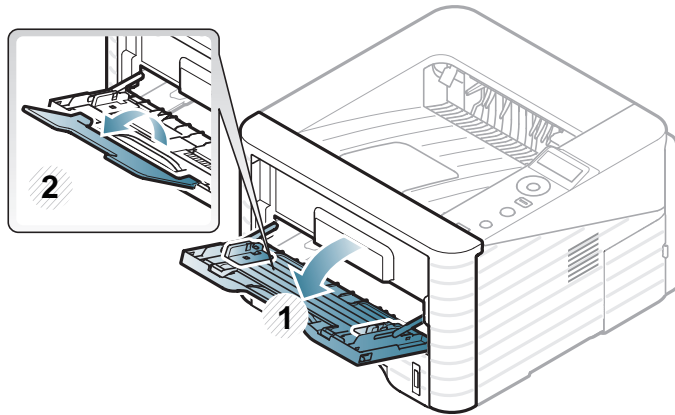

- 2 Adjust the multi-purpose tray paper width guides to the width of the paper.

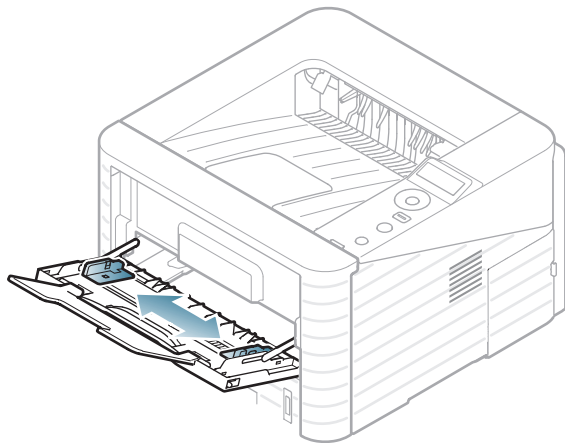

- 3 Flex or fan the edge of the paper stack to separate the pages before loading paper.

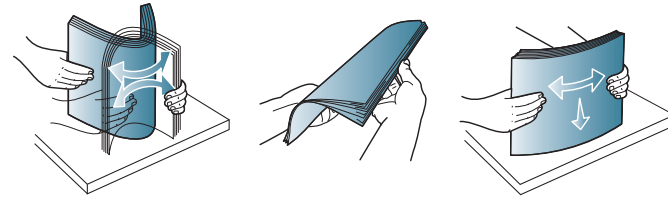

- 4 Load the paper. Squeeze the multi-purpose tray paper width guides and adjust them to the width of the paper.

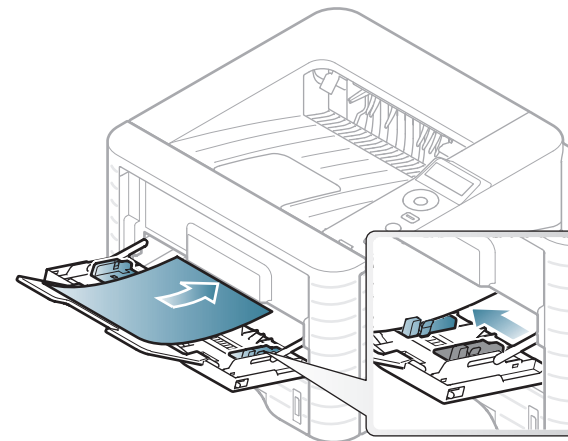

- 5 Set the paper type and size from the control panel (see "Setting the paper size and type" on page 16).



The settings set from the machine's driver override the settings on the control panel.

- a To print from an application, open an application and start the print menu.
- b Open **Printing Preferences** (see "Opening printing preferences" on page 19).
- c Press the **Paper** tab in **Printing Preferences** and select an appropriate paper type.
For example, if you want to use a label, set the paper type to **Label**.
- d Select **MP Tray** in paper source, then press **OK**.
- e Start printing in application.



Printing on special media

The table below shows the special media usable in each tray.

The media types are shown in the **Printing Preferences**. Select the proper media type to get the highest printing quality.



- When using special media, we recommend you feed one sheet at a time (see "Print media specifications" on page 4).
- **Printing the special media (Face up)**
If special media are printed out with curl, wrinkles, crease, or black bold lines, open the rear cover and pull down the pressure lever as shown below and try printing again. Keep the rear cover opened during printing.

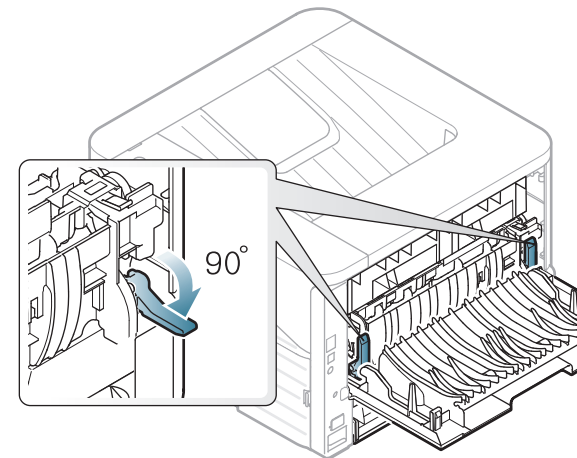

To see for paper weights for each sheet, refer to "Print media specifications" on page 4.

Types	Tray 1	Optional tray	Multi-purpose tray
Plain	?	?	?
Thick	?	?	?

Types	Tray 1	Optional tray	Multi-purpose tray
Thicker			?
Thin	?	?	?
Bond	?	?	?
Color			?
CardStock	?	?	?
Labels			?
Transparency			?
Envelope			?
Preprinted			?
Cotton			?
Recycled	?	?	?
Archive	?	?	?

(?: Included, Blank: Not available)

Envelope

Printing successfully on envelopes depends upon the quality of the envelopes.

To print an envelope, place it as shown in the following figure.

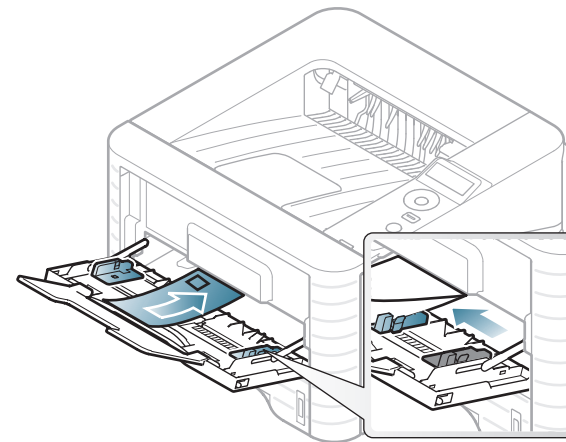

If envelopes are printed out with wrinkles, crease, or black bold lines, open the rear cover and pull down the pressure lever on the right side about 90 degrees and try printing again. Keep the rear cover opened during printing.

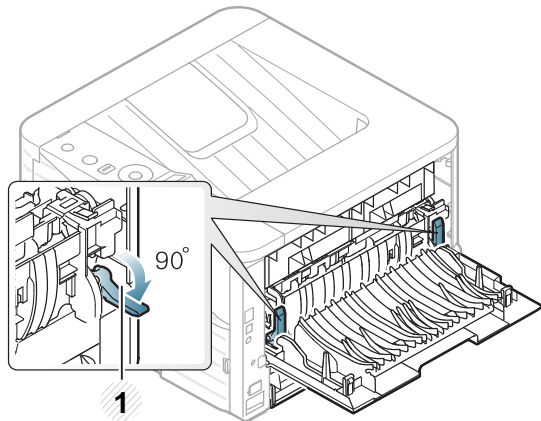

1 Pressure lever

- When selecting envelopes, consider the following factors:
 - **Weight:** should not exceed 90 g/m² otherwise; jams may occur.
 - **Construction:** should lie flat with less than 6 mm curl and should not contain air.
 - **Condition:** should not be wrinkled, nicked, nor damaged.
 - **Temperature:** should resist the heat and pressure of the machine during operation.
- Use only well-constructed envelopes with sharp and well-creased folds.
- Do not use stamped envelopes.
- Do not use envelopes with clasps, snaps, windows, coated lining, self-adhesive seals, or other synthetic materials.
- Do not use damaged or poorly made envelopes.

- Be sure the seam at both ends of the envelope extends all the way to the corner of the envelope.

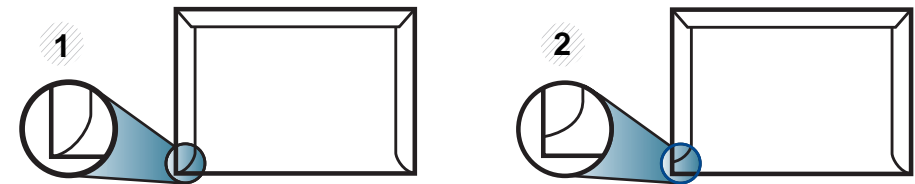

- 1 Acceptable
- 2 Unacceptable

- Envelopes with a peel-off adhesive strip or with more than one flap that folds over to seal must use adhesives compatible with the machine's fusing temperature for 0.1 second (about 170°C (338 °F)). The extra flaps and strips might cause wrinkling, creasing, or jams, and may even damage the fuser.
- For the best print quality, position margins no closer than 15 mm from the edges of the envelope.
- Avoid printing over the area where the envelope's seams meet.

Transparency

To avoid damaging the machine, use only transparencies designed for use in laser printers.

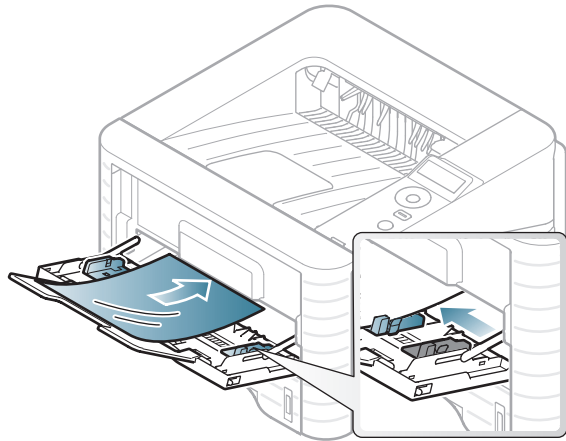

- Must withstand the machine's fusing temperature.
- Place them on a flat surface after removing them from the machine.
- Do not leave unused transparencies in the paper tray for long. Dust and dirt may accumulate on them, resulting in spotty printing.
- To avoid smudging caused by fingerprints, handle them carefully.
- To avoid fading, do not expose printed transparencies to prolonged sunlight.
- Ensure that transparencies are not wrinkled, curled, or have any torn edges.

- Do not use transparencies that separate from the backing sheet.
- To prevent transparencies from sticking to each other, do not let the printed sheets stack up as they are being printed out.
- Recommended media: Transparency for a color laser printer by Xerox, such as 3R 91331(A4), 3R 2780 (Letter)

Labels

To avoid damaging the machine, use only labels designed for use in laser printers.

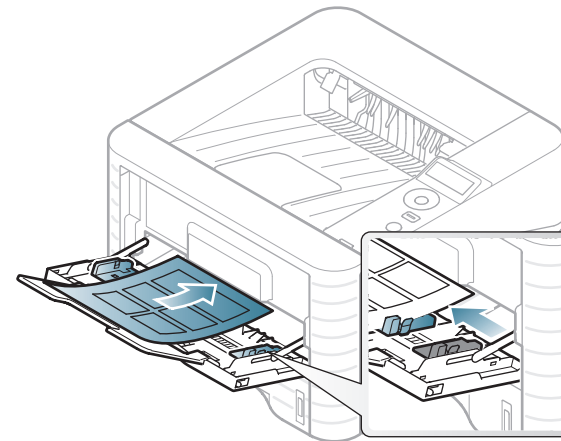

- When selecting labels, consider the following factors:
 - **Adhesives:** Should be stable at your machine's fusing temperature. Check your machine's specifications to view the fusing temperature (about 170°C (338°F)).

- **Arrangement:** Only use labels with no exposed backing between them. Labels can peel off sheets that have spaces between the labels, causing serious jams.
- **Curl:** Must lie flat with no more than 13 mm of curl in any direction.
- **Condition:** Do not use labels with wrinkles, bubbles, or other indications of separation.
- Make sure that there is no exposed adhesive material between labels. Exposed areas can cause labels to peel off during printing, which can cause paper jams. Exposed adhesive can also cause damage to machine components.
- Do not run a sheet of labels through the machine more than once. The adhesive backing is designed for only a single pass through the machine.
- Do not use labels that are separating from the backing sheet or are wrinkled, bubbled, or otherwise damaged.

Card stock/ Custom-sized paper

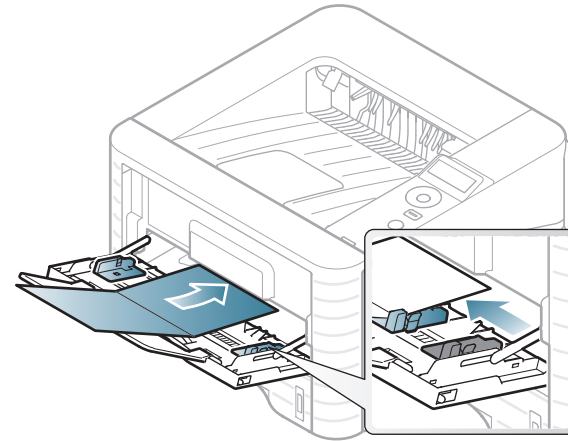

- In the software application, set margins at least 6.4 mm (0.25 inches) away from the edges of the material.

Preprinted paper

When loading preprinted paper, the printed side should be facing up with an uncurled edge at the front. If you experience problems with paper feeding, turn the paper around. Note that print quality is not guaranteed.

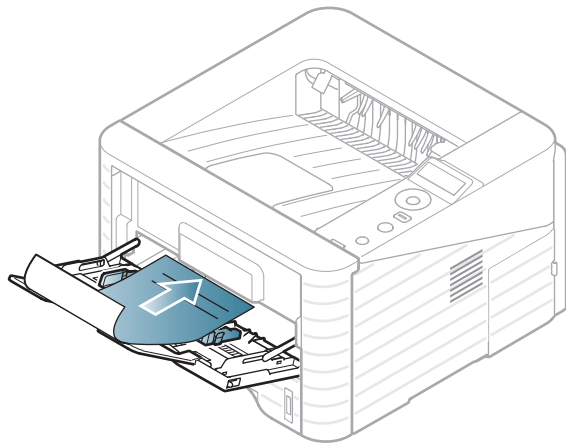

- Must be printed with heat-resistant ink that will not melt, vaporize, or release hazardous emissions when subjected to the machine's fusing temperature for 0.1 second (about 170°C (338°F)).
- Must be non-flammable and should not adversely affect machine rollers.
- Before you load preprinted paper, verify that the ink on the paper is dry. During the fusing process, wet ink can come off preprinted paper, reducing print quality.





Setting the paper size and type

After loading paper in the paper tray, set the paper size and type using the control panel buttons.



- The settings set from the machine's driver override the settings on the control panel.
- For models that do not have the display screen on the control panel, this feature is not applicable.

- 1 Press  (**Menu**) button on the control panel.
- 2 Press **Paper** > **OK** > Select the tray you want > **OK**.
- 3 Press **Paper Size** > **OK** > Select the option you want > **OK**.
- 4 Press **Paper Type** > **OK** > Select the option you want > **OK**.
- 5 Press  (**Cancel**) to return to ready mode.



If you want to use special-sized paper such as billing paper, select **Custom** in the **Paper** tab in the **Printing Preferences** (see "Opening printing preferences" on page 19).



Printing



If you are a Macintosh, Linux, or Unix OS user, refer to the Advanced Guide.

The following **Printing Preferences** window is for Notepad in Windows 7.

- 1 Open the document you want to print.
- 2 Select **Print** from the **File** menu.
- 3 Select your machine from the **Select Printer** list.

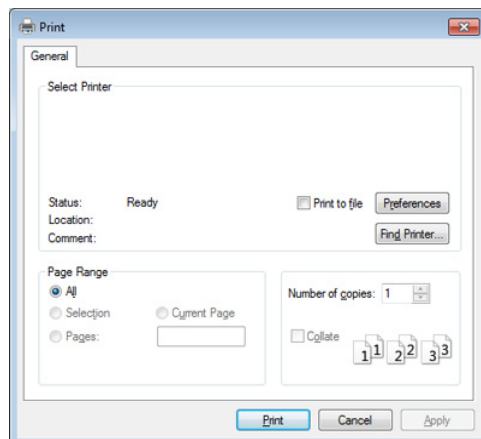

- 4 The basic print settings including the number of copies and print range are selected within the **Print** window.





To take advantage of the advanced printing features, click **Properties** or **Preferences** from the **Print** window (see "Opening printing preferences" on page 19).

- 5 To start the print job, click **OK** or **Print** in the **Print** window.



Canceling a print job





If the print job is waiting in the print queue or print spooler, cancel the job as follows:

- You can access this window by simply double-clicking the machine icon () in the Windows task bar.
- You can also cancel the current job by pressing  (**Cancel**) on the control panel.



Opening printing preferences



- The **Printing Preferences** window that appears in this user's guide may differ depending on the machine in use.
- When you select an option in **Printing Preferences**, you may see a warning mark  or . An  mark means you can select that certain option but it is not recommended, and an  mark means you cannot select that option due to the machine's setting or environment.

- 1 Open the document you want to print.
- 2 Select **Print** from the file menu.
- 3 Select your machine from the **Select Printer**.

4 Click **Properties** or **Preferences**.

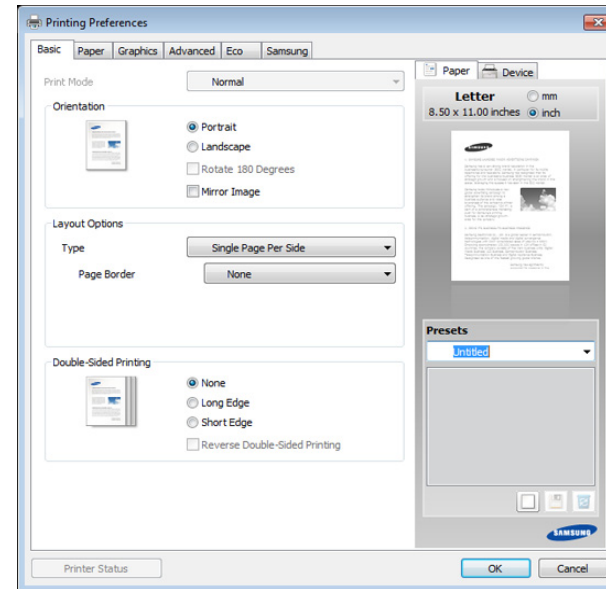

You can check the machine's current status using the **Printer Status** button (see Advanced Guide).

Using a favorite setting

The **Presets** option, which is visible on each preferences tab except for the **Samsung** tab, allows you to save the current preferences for future use.

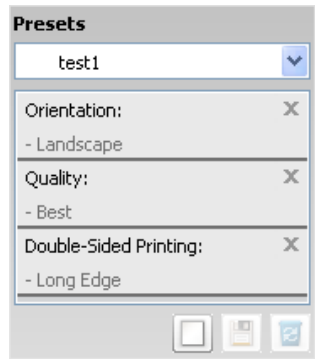

To save a **Presets** item, follow these steps:

- 1 Change the settings as needed on each tab.
- 2 Enter a name for the item in the **Presets** input box.



- 3 Click (**Add**). When you save **Presets**, all current driver settings are saved.



Select more options and click  (**Update**), settings will be added to the Presets you made. To use a saved setting, select it from the **Presets** drop-down list. The machine is now set to print according to the settings you have selected. To delete saved settings, select it from the **Presets** drop-down list and click  (**Delete**).

You can also restore the printer driver's default settings by selecting **Default Preset** from the **Presets** drop-down list.



Using help

Click the option you want to know on the **Printing Preferences** window and press **F1** on your keyboard.



Eco printing

The **Eco** function cuts toner consumption and paper usage. The **Eco** function allows you to save print resources and lead you to eco-friendly printing.

If you press the **Eco** button from the control panel, eco mode is enabled. The default setting of eco mode is duplex (long edge), 2-up, skip blank pages, and toner save.

Setting eco mode on the control panel



- The settings set from the machine's driver override the settings on the control panel.
- For models that do not have the display screen on the control panel, this feature is not applicable.

- 1 Press  (**Menu**) button on the control panel.
- 2 Press **System Setup > OK > Eco Setup > OK**.
- 3 Press **OK** select the mode you want.
 - **Default Mode:** Select this to turn on or off the eco mode. (Duplex (long edge)/Toner save/2-up/Skip blank pages)
 - **Off:** Set the eco mode off.
 - **On:** Set the eco mode on.



If you set the eco mode on with a password from the SyncThru™ Web Service (**Settings** tab > **Machine Settings** > **System** > **Eco** > **Settings**), the **Onforce** message appears. You have to enter the password to change the eco mode status.

- **Change Temp.:** Select the eco template.
 - **Default Eco:** The default setting of eco mode is duplex, 2-up, skip blank pages, and toner save.
 - **Custom Eco:** Follow the settings from SyncThru™ Web Service. Before you select this item, you must set the eco function in SyncThru™ Web Service > **Settings** tab > **Machine Settings** > **System** > **Eco** > **Settings**.

Setting eco mode on the driver

Open the Eco tab to set eco mode. When you see the eco image () , that means the eco mode is currently enabled.

► Eco options

- **Printer Default:** Follows the settings from the machine's control panel.
- **None:** Disables eco mode.
- **Eco Printing:** Enables eco mode. Activate the various eco items you want to use.
- **Password:** If the administrator fixed to enable the eco mode, you have to enter the password to change the status.

► Result simulator

Result Simulator shows the results of reduced emission of carbon dioxide, used electricity, and the amount of saved paper in accordance with the settings you selected.

- The results are calculated on the basis that the total number of printed paper is one hundred without a blank page when the eco mode is disabled.
- Refer to the calculation coefficient about CO₂, energy, and paper from **IEA**, the index of Ministry of Internal Affairs and Communication of Japan and www.remanufacturing.org.uk. Each model has a different index.
- The power consumption in printing mode refers to the average printing power consumption of this machine.
- The actual saved or reduced amount may differ depending on the operating system used, computing performance, application software, connection method, media type, media size, job complexity, etc.



3. Maintenance

This chapter provides information about purchasing supplies, accessories and maintenance parts available for your machine.

- **Ordering supplies and accessories** 50
- **Available supplies** 51
- **Available accessories** 52
- **Available maintenance parts** 53
- **Redistributing toner** 54
- **Replacing the toner cartridge** 56
- **Upgrading a memory module** 58
- **Monitoring the supplies life** 60
- **Setting the toner low alert** 61
- **Cleaning the machine** 62



Available accessories may differ from country to country. Contact your sales representatives to obtain the list of available supplies, and maintenance parts.

To order Samsung-authorized supplies, accessories, and maintenance parts, contact your local Samsung dealer or the retailer where you purchased your machine. You can also visit www.samsung.com/supplies, and then select your country/region to obtain the contact information for service.

When supplies reach the end of their life spans, you can order the following types of supplies for your machine:

Type	Average yield ^a	Part name
Standard yield toner cartridge	Approx. 2,000 pages	MLT-D205S
High yield toner cartridge	Approx. 5,000 pages	MLT-D205L
Extra high yield toner cartridge^b	Approx. 10,000 pages	MLT-D205E

a. Declared yield value in accordance with ISO/IEC 19752.

b. The toner cartridge is available only for ML-371x Series and ML-3310ND/SIT.



Depending on the options and job mode used, the toner cartridge's lifespan may differ.



When purchasing new toner cartridges or other supplies, these must be purchased in the same country as the machine you are using. Otherwise, new toner cartridges or other supplies will be incompatible with your machine due to different configurations of toner cartridges and other supplies according to the specific country conditions.



Samsung does not recommend using non-genuine Samsung toner cartridge such as refilled or remanufactured toner. Samsung cannot guarantee non-genuine Samsung toner cartridge's quality. Service or repair required as a result of using non-genuine Samsung toner cartridges will not be covered under the machine's warranty.

You can purchase and install accessories to enhance your machine's performance and capacity.



Some features and optional goods may not be available depending on models or countries (see "Features by models" on page 7).

Accessory	Function	Part name
Memory module	Extends your machine's memory capacity.	<ul style="list-style-type: none">CLP-MEM201: 128 MBCLP-MEM202: 256 MB
Tray 2	If you are experiencing frequent paper supply problems, you can attach an additional tray.	<ul style="list-style-type: none">ML-3310ND/ML-3710 Series: ML-S3710AML-3312ND/ML-3712 Series: ML-S3712A
IEEE 1284 parallel connector	<p>Allows you to use various interface.</p> <div><ul style="list-style-type: none">When installing the printer driver with an IEEE1284 parallel connector, the machine might not be found and after installing the printer driver, only basic printing features are available.If you want to check the machine's status or set the settings, connect the machine to a computer with a USB cable or a network.If you use the IEEE 1284 parallel connector, you can not use the USB cable.</div>	ML-PAR100

To purchase maintenance parts, contact the source where you bought the machine. Replacing maintenance parts can be performed only by an authorized service provider, dealer, or the retailer where you bought the machine. The warranty does not cover the replacement of any maintenance parts once it has reached its “Average yield”.

Maintenance parts are replaced at specific intervals to avoid print quality and paper feed problems resulting from worn parts, see table below. The purpose of which is to maintain your machine in top working condition. The maintenance parts below should be replaced when the life span of each item has been met.

Parts	Average yield ^a
Transfer roller	Approx. 100,000 pages
Fuser unit	Approx. 90,000 pages
Pickup roller	Approx. 90,000 pages
Retard roller	Approx. 60,000 pages

a. It will be affected by the operating system used, computing performance, application software, connecting method, media type, media size and job complexity.

When the toner cartridge is near the end of its life:

- White streaks or light printing occurs and/or density variation side to side.
- The **Status** LED blinks red.

If this happens, you can temporarily improve print quality by redistributing the remaining toner in the cartridge. In some cases, white streaks or light printing will still occur even after you have redistributed the toner.

- 1 Open the front cover and pull the toner cartridge out.

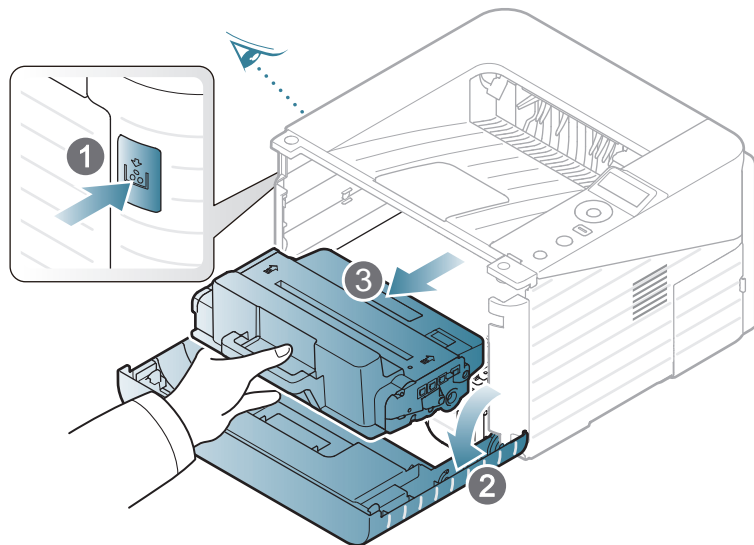

- 2 Thoroughly roll the cartridge five or six times to distribute the toner evenly inside the cartridge.

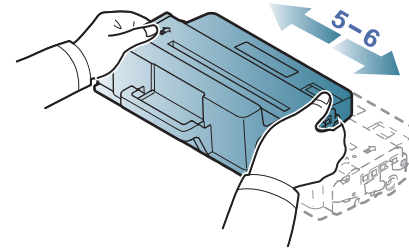

If toner gets on your clothing, wipe it off with a dry cloth and wash clothing in cold water: hot water sets toner into fabric.



Do not touch the green underside of the toner cartridge. Use the handle on the cartridge to avoid touching this area.

- 3 Hold the toner cartridge by the handle and slowly insert the cartridge into the opening in the machine.

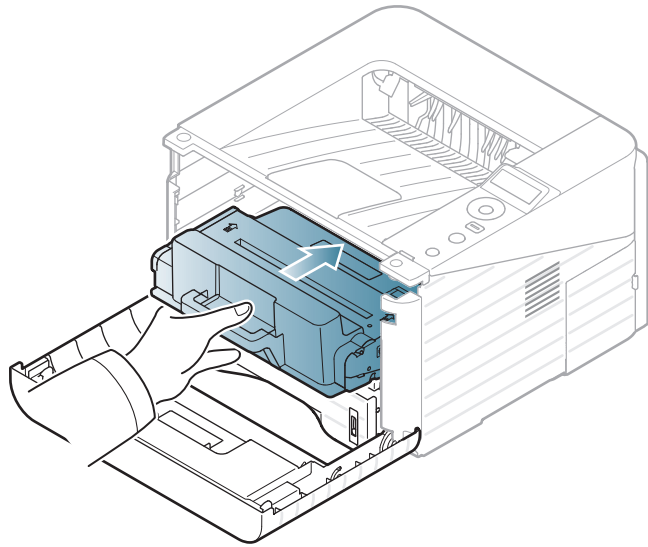

- 4 Close the front cover. Ensure that the cover is securely closed.



Click this link to open an animation about replacing a toner cartridge.

When a toner cartridge has reached the end of life, the machine will stop printing.

- 1 Open the front cover and pull the toner cartridge out.

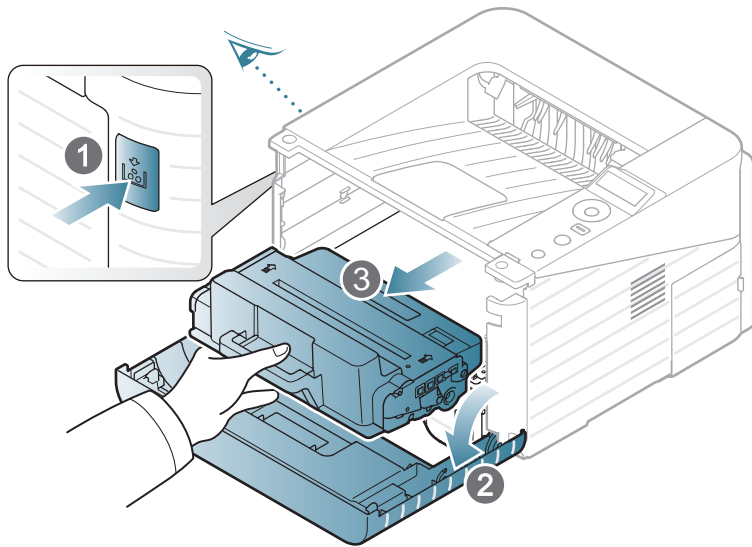

- 2 Remove the new toner cartridge from its bag.

- 3 Remove the label from the toner cartridge as shown below.

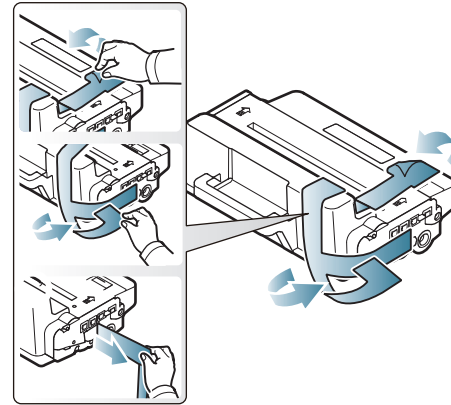

- 4 Thoroughly shake side to side the cartridge five or six times to distribute the toner evenly inside the cartridge.

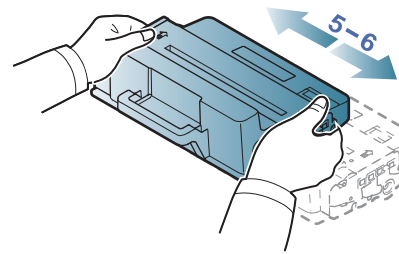

If toner gets on your clothing, wipe it off with a dry cloth and wash clothing in cold water: hot water sets toner into fabric.



Do not touch the green underside of the toner cartridge. Use the handle on the cartridge to avoid touching this area.

- 5 Hold the toner cartridge by the handle and slowly insert the cartridge into the opening in the machine.

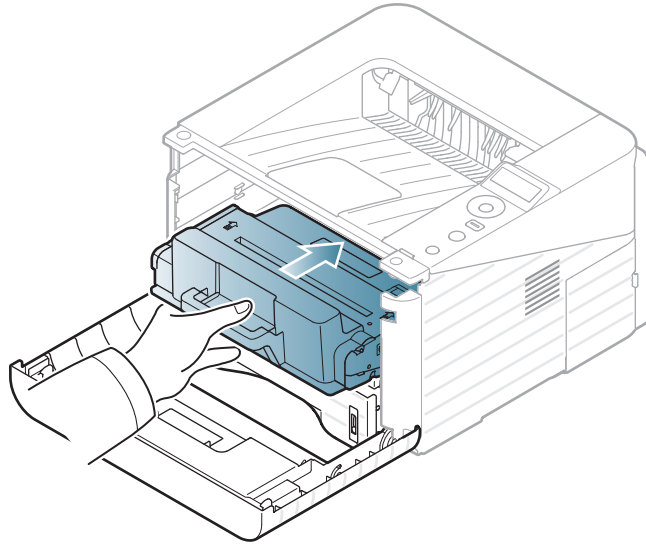

- 6 Close the front cover. Make sure that the cover is securely closed.

Your machine has a dual in-line memory module (DIMM). Use this memory module slot to install additional memory.

Order information is provided for additional memory module. (See "Available accessories" on page 52.)



Installing a memory module

- 1 Turn the machine off and unplug all cables from the machine.
- 2 Grasp the control board cover and remove it.

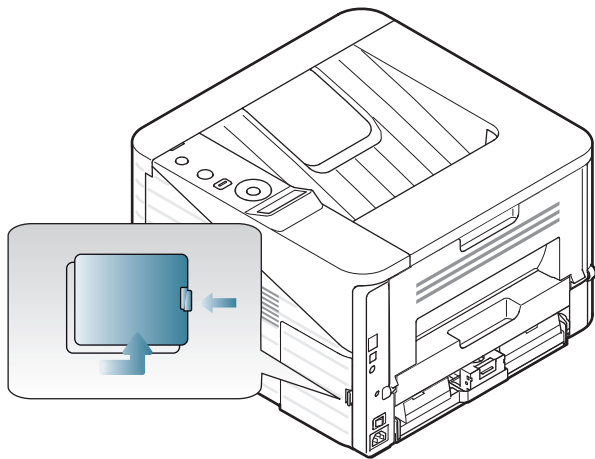

- 3 Remove the new memory module from its bag.

- 4 Holding the memory module by the edges, align the memory module on the slot at about a 30-degree tilt. Make sure that the notches of the module and the grooves on the slot fit each other.

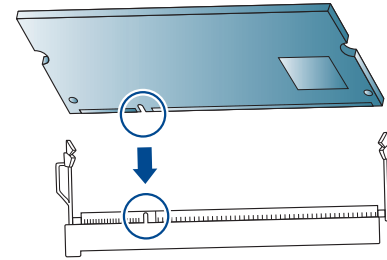

The notches and grooves illustrated above may not match those on an actual memory module and its slot.

- 5 Press the memory module into the slot with care until you hear a 'click'.

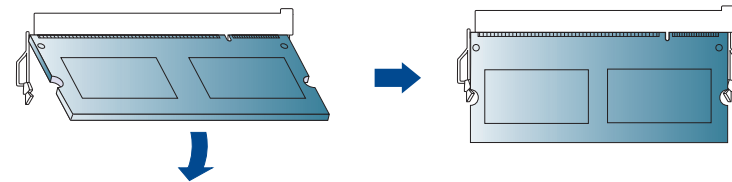

Do not press the memory module strongly or the module may be damaged. If the module does not seem to fit into the slot properly, carefully try the previous procedure again.

- 6 Replace the control board cover.
- 7 Reconnect the power cord and machine cable and turn the machine on.

To view the supply life indicators, follow the steps below:

- 1 Press  (**Menu**) on the control panel.
- 2 Press **System Setup** > **OK** > **Maintenance** > **OK**.
- 3 Press **Supplies Info** > **OK**.
- 4 Press **OK** to select the option you want.



For models that do not support the display screen on the control panel, this feature is not applicable.

If the amount of toner in the cartridge is low, a message or LED informing the user to change the toner cartridge appears. You can set the option for whether or not this message or LED appears.

- 1 Press  (**Menu**) on the control panel.
- 2 Press **System Setup > OK > Maintenance > OK**.
- 3 Press **Toner Low Alert > OK**.
- 4 Select the option you want, then press **OK**.



For models that do not support the display screen on the control panel, this feature is not applicable.

If printing quality problems occur or if you use your machine in a dusty environment, you need to clean your machine regularly to keep it in the best printing condition and use your machine longer.



- Cleaning the cabinet of the machine with cleaning materials containing large amounts of alcohol, solvents, or other strong substances can discolor or distort the cabinet.
- If your machine or the surrounding area is contaminated with toner, we recommend you use a cloth or tissue dampened with water to clean it. If you use a vacuum cleaner, toner blows in the air and might be harmful to you.



Cleaning the outside

Clean the machine cabinet with a soft, lint-free cloth. Dampen the cloth slightly with water, but be careful not to let any water drip onto or into the machine.



Cleaning the inside

During the printing process, paper, toner, and dust particles can accumulate inside the machine. This buildup can cause print quality problems, such as toner specks or smearing. Cleaning the inside of the machine clears and reduces these problems.

- 1 Turn the machine off and unplug the power cord. Wait for the machine to cool down.
- 2 Open the front cover and pull the toner cartridge out. Set it on a clean flat surface.

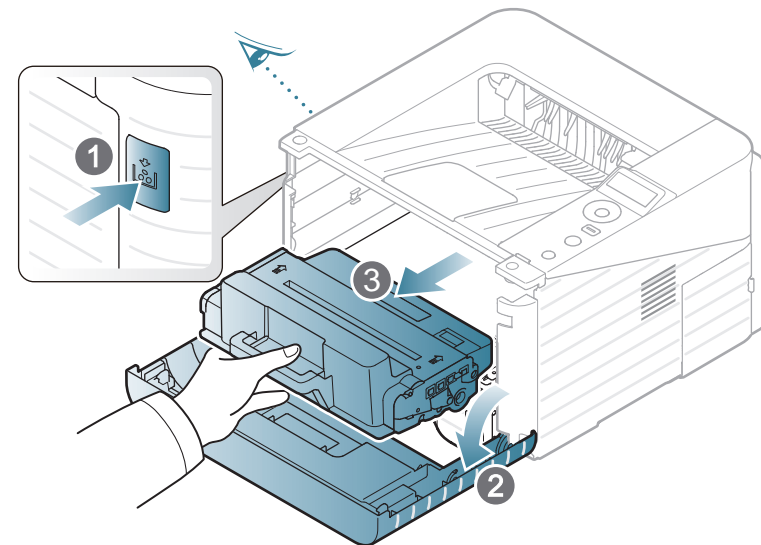



- To prevent damage to the toner cartridge, do not expose it to light for more than a few minutes. Cover it with a piece of paper, if necessary.
- Do not touch the green surface underside of the toner cartridge. Use the handle on the cartridge to avoid touching this area.



While cleaning the inside of the machine, be careful not to damage the transfer roller or any other inside parts. Do not use solvents such as benzene or thinner. Printing quality problems can occur and cause damage to the machine.

- 3** With a dry, lint-free cloth, wipe away any dust and spilled toner from the toner cartridge area.

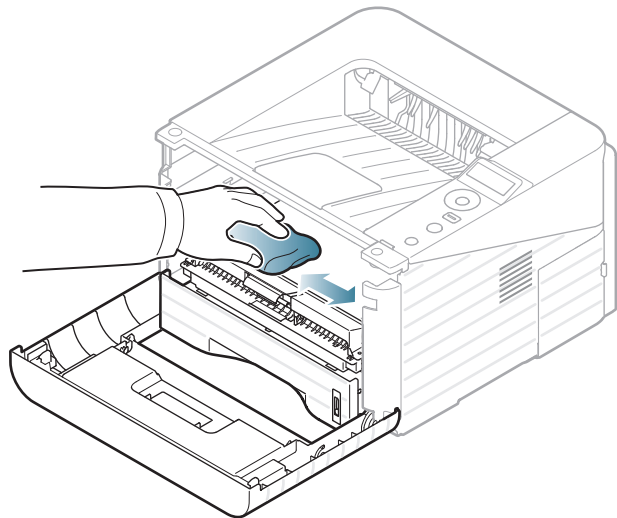

- 4** Reinsert the toner cartridge and close the front cover.



Cleaning the pickup roller

- 1 Turn the machine off and unplug the power cord. Wait for the machine to cool down.
- 2 Pull out tray 1.

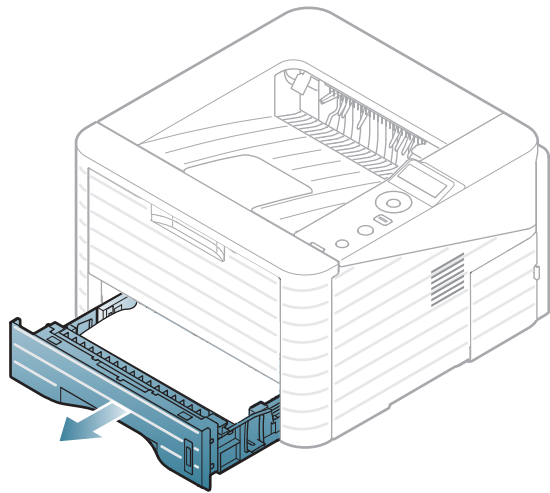

- 3 Clean the pickup roller with a soft, lint-free cloth.

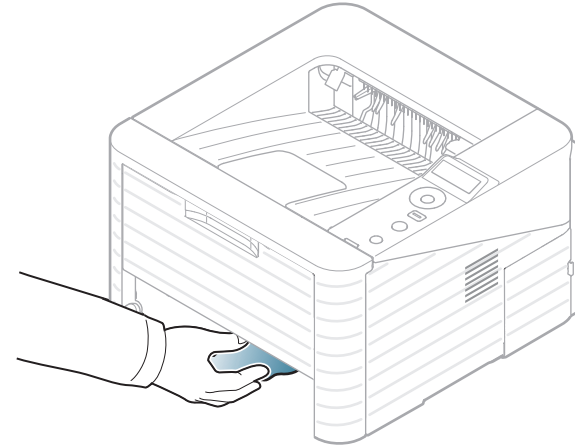

- 4 Insert the tray back into the machine.

4. Troubleshooting

This chapter gives helpful information for what to do if you encounter an error.

- **Tips for avoiding paper jams** 67
- **Clearing paper jams** 68
- **Understanding the status LED** 74
- **Understanding display messages** 77



This chapter gives helpful information for what to do if you encounter an error.

If your machine has a display screen, check the message on the display screen first to solve the error. If you cannot find a solution to your problem in this chapter, refer to the **Troubleshooting** chapter in the Advanced User's Guide.

If you cannot find a solution in the User's Guide or the problem persists, call for service.

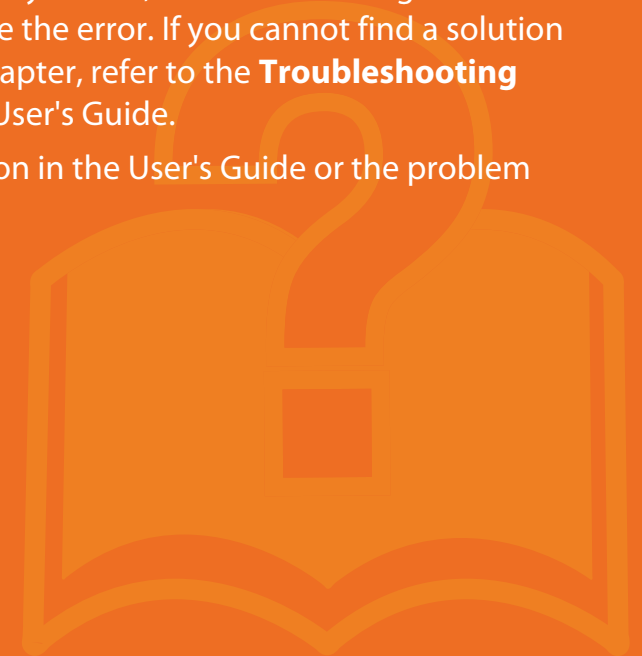

By selecting the correct media types, most paper jams can be avoided. To avoid paper jams, refer to the following guidelines:

- Ensure that the adjustable guides are positioned correctly (see "Tray overview" on page 32).
- Do not overload the tray. Ensure that the paper level is below the paper capacity mark on the inside of the tray.
- Do not remove paper from the tray while your machine is printing.
- Flex, fan, and straighten paper before loading.
- Do not use creased, damp, or highly curled paper.
- Do not mix paper types in a tray.
- Use only recommended print media (see "Print media specifications" on page 85).



To avoid tearing the paper, pull the jammed paper out slowly and gently.



In tray 1



Click this link to open an animation about clearing a jam.

1 Open and close the front cover. The jammed paper is automatically ejected from the machine.

If the paper does not exit, go to the next step.

2 Pull out tray 1 .

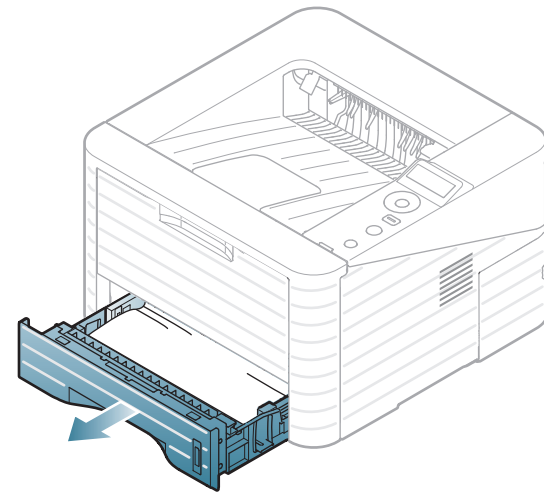

- 3 Remove the jammed paper by gently pulling it straight out.

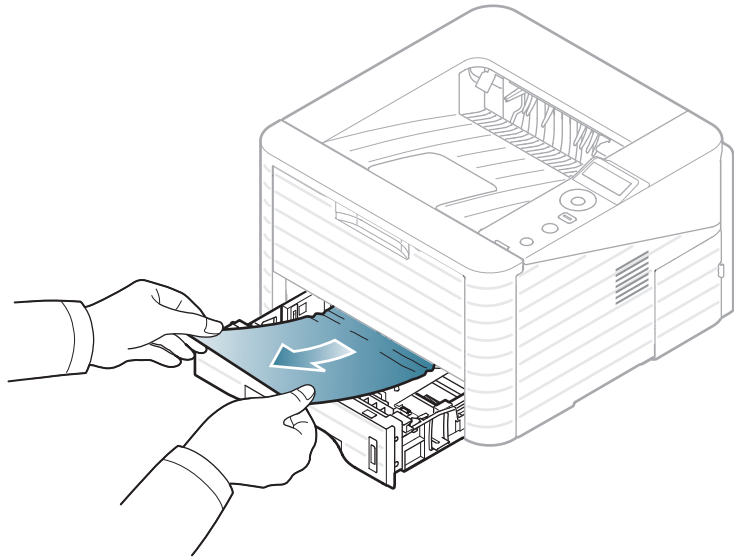

If the paper does not move when you pull, or if you do not see the paper in this area, check the fuser area around the toner cartridge (see "Inside the machine" on page 70).

- 4 Insert tray 1 back into the machine until it snaps into place. Printing automatically resumes.



In optional tray2



Click this link to open an animation about clearing a jam.

- 1 Pull out optional tray 2.
- 2 Remove the jammed paper from the machine.

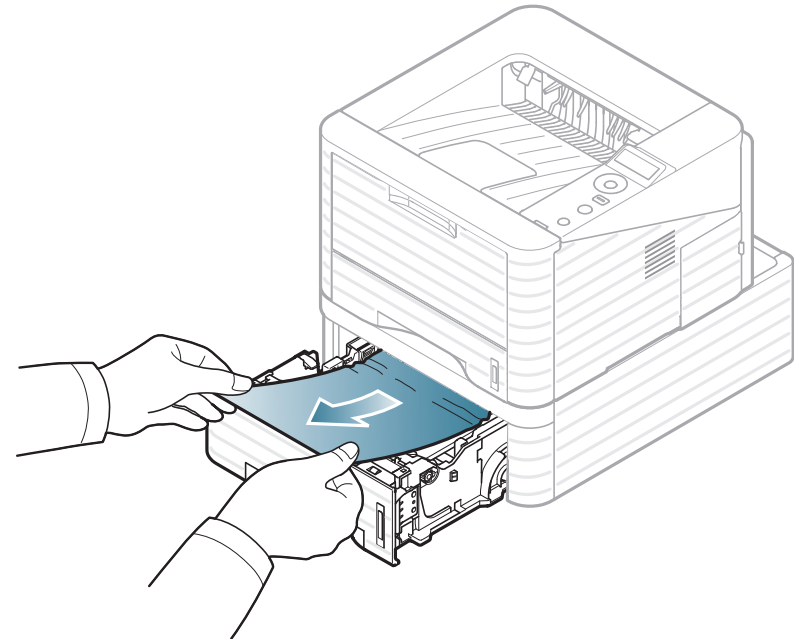

If the paper does not move when you pull or if you do not see the paper in this area, stop and go to the next step.

3 Pull tray 1 half-way out.

4 Pull the paper straight up and out.

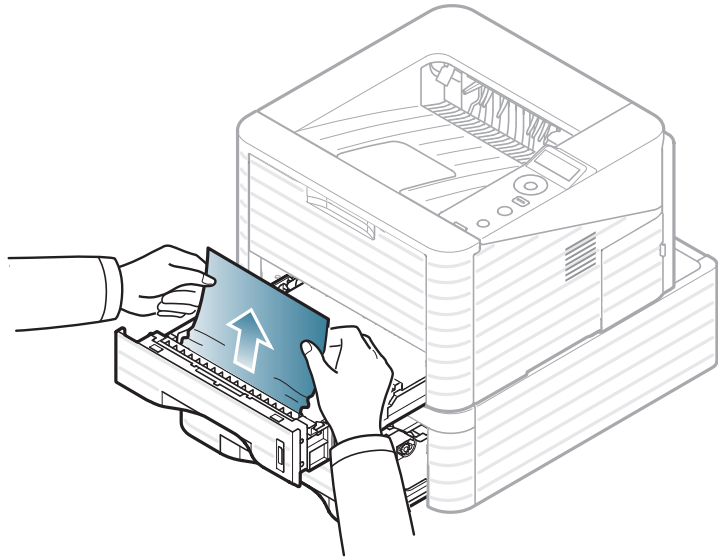

5 Insert the trays back into the machine. Printing automatically resumes.



In the multi-purpose tray



Click this link to open an animation about clearing a jam.

1 If the paper is not feeding properly, pull the paper out of the machine.

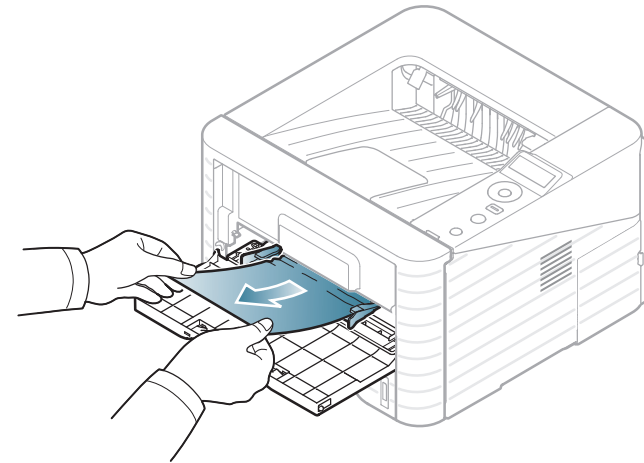

2 Open and close the front cover to resume printing.



Inside the machine



Click this link to open an animation about clearing a jam.



The fuser area is hot. Take care when removing paper from the machine.

- 1 Open the front cover and pull the toner cartridge out.

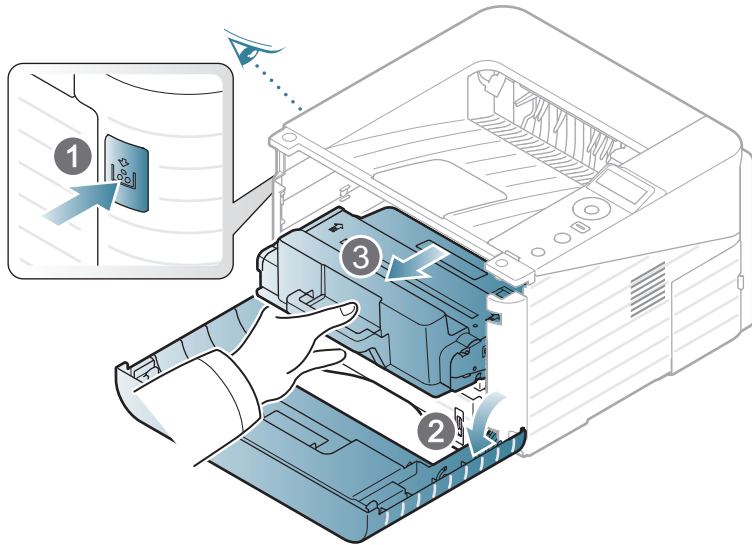

- 2 Remove the jammed paper by gently pulling it straight out.

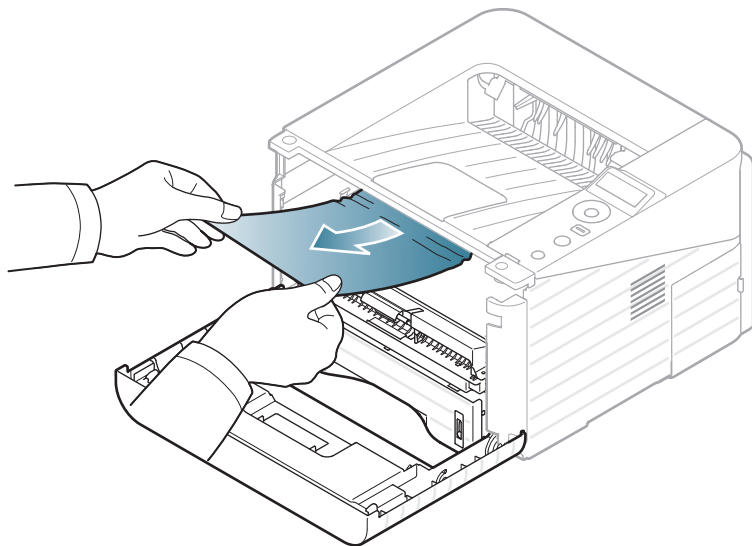

- 3 Replace the toner cartridge and close the front cover. Printing automatically resumes.



In the exit area



Click this link to open an animation about clearing a jam.

- 1 Open and close the front cover. The jammed paper is automatically ejected from the machine.
If you do not see the jammed paper, go to the next step.

- 2 Gently pull the paper out of the output tray.

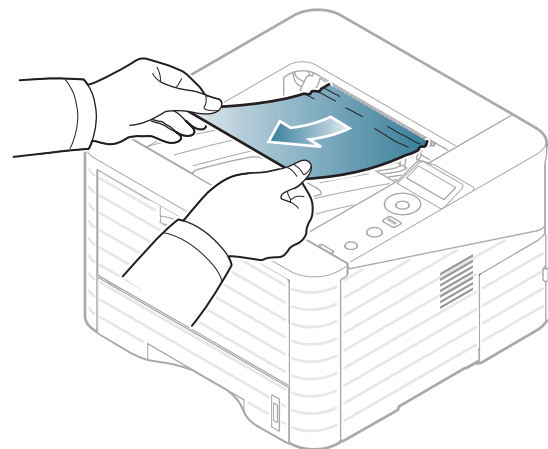

If you do not see the jammed paper or if there is any resistance when you pull, stop and go to the next step.

3 Open the rear cover.

4 Remove the jammed paper as shown in the following figure.

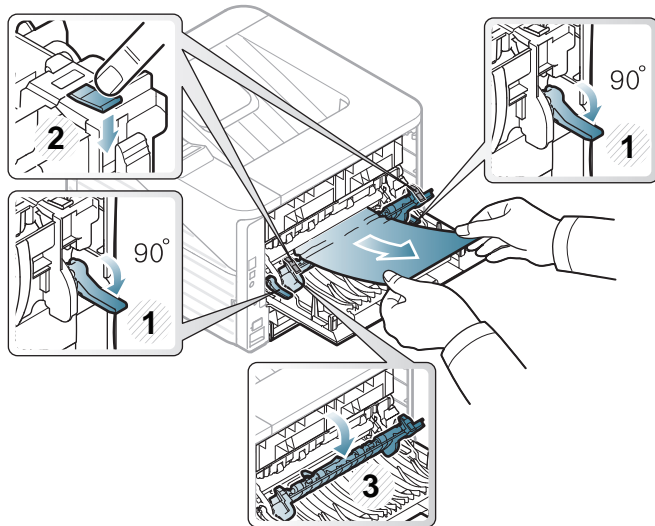

5 Close the rear cover. Printing automatically resumes.

1 Pull the duplex unit out of the machine.

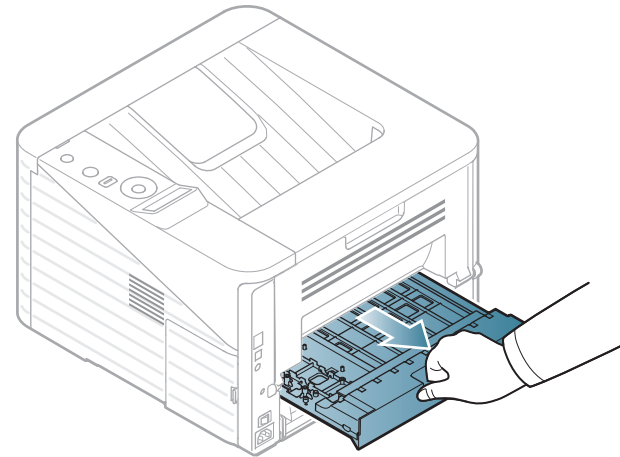

2 Remove the jammed paper from the duplex unit.

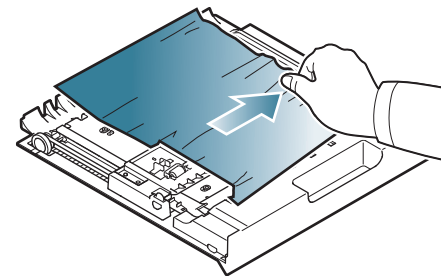

In the duplex unit area



Click this link to open an animation about clearing a jam.

If the paper does not come out with the duplex unit, remove the paper from the bottom of the machine.

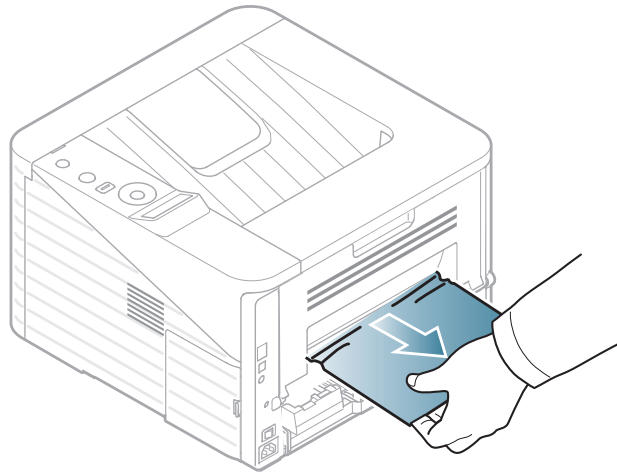

If you still do not see the paper, go to the next step.

3 Insert the duplex unit into the machine.

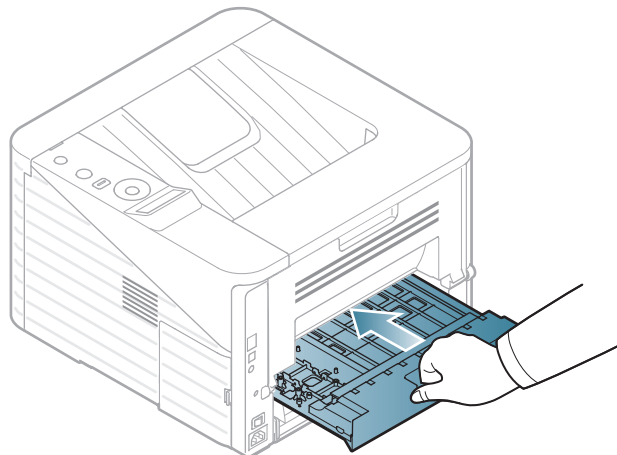

4 Open the rear cover.

5 Remove the jammed paper as shown in the following figure.

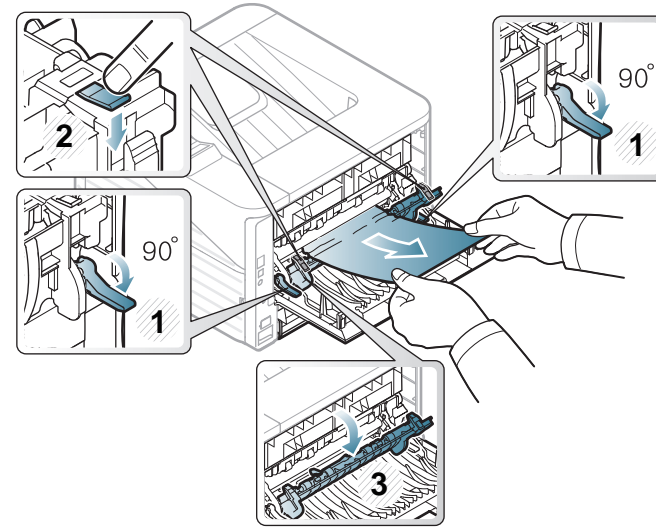

6 Close the rear cover. Printing automatically resumes.

The color of the LED indicates the machine's current status.



- Some LEDs may not be available depending on model or country.
- To resolve the error, look at the error message and its instructions from the troubleshooting part.
- You also can resolve the error with the guideline from the computers's Samsung Printer Status or Smart Panel program window.
- If the problem persists, call a service representative.





Status LED

Status		Description	
 (Status LED)	Off	The machine is off-line.	
	Green	Blinking	<ul style="list-style-type: none"> When the backlight slowly blinks, the machine is receiving data from the computer. When the backlight blinks rapidly, the machine is printing data.
		On	<ul style="list-style-type: none"> The machine is on-line and can be used.
	Red	Blinking	<ul style="list-style-type: none"> A minor error has occurred and the machine is waiting for the error to be cleared. Check the display message. When the problem is cleared, the machine resumes. For some models that does not support the display screen on the control panel, this feature is not applicable. Small amount of toner is left in the cartridge. The estimated cartridge life of toner is close. Prepare a new cartridge for replacement. You may temporarily increase the printing quality by redistributing the toner (see "Redistributing toner" on page 54).
On		<ul style="list-style-type: none"> A toner cartridge has almost reached its estimated cartridge life^a. It is recommended to replace the toner cartridge (see "Replacing the toner cartridge" on page 56). The cover is opened. Close the cover. There is no paper in the tray. Load paper in the tray. The machine has stopped due to a major error. Check the display message (see "Understanding display messages" on page 77). A paper jam has occurred (see "Clearing paper jams" on page 68). 	

- a. Estimated cartridge life means the expected or estimated toner cartridge life, which indicates the average capacity of print-outs and is designed pursuant to ISO/IEC 19752. The number of pages may be affected by operating environment, printing interval, graphics, media type and media size. Some amount of toner may remain in the cartridge even when red LED is on and the printer stops printing.



Jam LED/ WPS LED

Status			Description
 (Jam LED)	Orange	On	A paper jam has occurred (see "Clearing paper jams" on page 68).
 (WPS LED)	Blue	On	When the machine is connected to a wireless network, WPS LED lights on blue (see Advanced Guide).

Messages appear on the control panel display to indicate the machine's status or errors. Refer to the tables below to understand the messages' and their meaning, and correct the problem, if necessary.



Checking display messages



- If a message is not in the table, reboot the power and try the printing job again. If the problem persists, call a service representative.
- When you call for service, provide the service representative with the contents of display message.
- Some messages may not appear on the display depending on the options or models.
- [error number] indicates the error number.



Paper Jam-related messages

Message	Meaning	Suggested solutions
Paper Jam in Tray 1	Paper has jammed in the paper feed area.	Clear the jam (see "In tray 1" on page 68).

Message	Meaning	Suggested solutions
Paper Jam in Tray 2	Paper has jammed in the optional tray.	Clear the jam (see "In optional tray2" on page 69).
Paper Jam in MP tray	Paper has jammed in the multi-purpose tray.	Clear the jam (see "In the multi-purpose tray" on page 70).
Paper Jam inside machine	Paper has jammed in the inside machine.	Clear the jam (see "Inside the machine" on page 70).
Paper Jam in exit area	Paper has jammed in the paper exit area.	Clear the jam (see "In the exit area" on page 71).
Paper Jam inside of duplex	Paper has jammed in the duplex area.	Clear the jam (see "In the duplex unit area" on page 72).

Toner-related messages

Message	Meaning	Suggested solutions
Install Toner	A toner cartridge is not installed.	Install a toner cartridge.
Not Compatible Toner cartridge	The toner cartridge you have installed is not for your machine.	Install a Samsung-genuine toner cartridge, designed for your machine.

Message	Meaning	Suggested solutions
<p>Replace new cartridge</p>	<p>The indicated toner cartridge has almost reached its estimated cartridge life. The machine might stop printing.</p> <div data-bbox="309 459 1070 1150" style="border: 1px solid #ccc; padding: 10px; margin-top: 10px;">  <p>Estimated cartridge life means the expected or estimated toner cartridge life, which indicates the average capacity of print-outs and is designed pursuant to ISO/IEC 19752 (see "Available supplies" on page 51). The number of pages may be affected by operating environment, printing interval, media type, percentage of image area, and media size. Some amount of toner may remain in the cartridge even when replace new cartridge appears and the machine stops printing.</p> </div>	<ul style="list-style-type: none"> You can choose Stop or Continue as shown on the control panel. If you select Stop, the printer stops printing and you cannot print any more without changing the cartridge. If you select Continue, the printer keeps printing but the printing quality cannot be guaranteed. Replace the toner cartridge for the best print quality when this message appears. Using a cartridge beyond this stage can result in printing quality issues (see "Replacing the toner cartridge" on page 56). <div data-bbox="1093 643 2199 1007" style="border: 1px solid #ccc; padding: 10px; margin-top: 10px;">  <p>Samsung does not recommend using non-genuine Samsung toner cartridge such as refilled or remanufactured. Samsung cannot guarantee non-genuine Samsung toner cartridge's quality. Service or repair required as a result of using non-genuine Samsung toner cartridges will not be covered under the machine warranty.</p> </div> <ul style="list-style-type: none"> If the machine stops printing, replace the toner cartridge (See "Replacing the toner cartridge" on page 56).
<p>Prepare new cartridge</p>	<p>Small amount of toner is left in the indicated cartridge. The estimated cartridge life of toner is close.</p>	<p>Prepare a new cartridge for a replacement. You may temporarily increase the printing quality by redistributing the toner (see "Redistributing toner" on page 54).</p>

Tray-related messages

Message	Meaning	Suggested solutions
Paper Empty in Tray 1	There is no paper in tray 1.	Load paper in tray 1 (see "Loading paper in the tray/ optional tray" on page 33).
Paper Empty in Tray 2	There is no paper in tray 2.	Load paper in tray 2 (see "Loading paper in the tray/ optional tray" on page 33).
Paper Empty in MP tray	There is no paper in the multi-purpose tray.	Load paper in the multi-purpose tray (see "Loading in multi-purpose tray" on page 35).
Output bin full Remove paper	The output tray is full.	Remove papers from the output tray, the printer resumes printing.

Network-related messages

Message	Meaning	Suggested solutions
Network Problem IP Conflict	The network IP address you have set is being used by someone else.	Check the IP address and reset it if necessary (see Advanced Guide).
802.1x Network Error	Fail to authenticate.	Check the network authentication protocol. If the problem persists, contact your network administrator.

Misc. messages

Message	Meaning	Suggested solutions
Door Open Close it	The front cover or rear cover is not securely latched.	Close the cover until it locks into place.
Error [error number] Call for service	A system error has occurred	Reboot the power and try the printing job again. If the problem persists, please call for service.

Message	Meaning	Suggested solutions
Error [error number] Turn off then on	The machine unit cannot be controlled.	Reboot the power and try the printing job again. If the problem persists, please call for service.

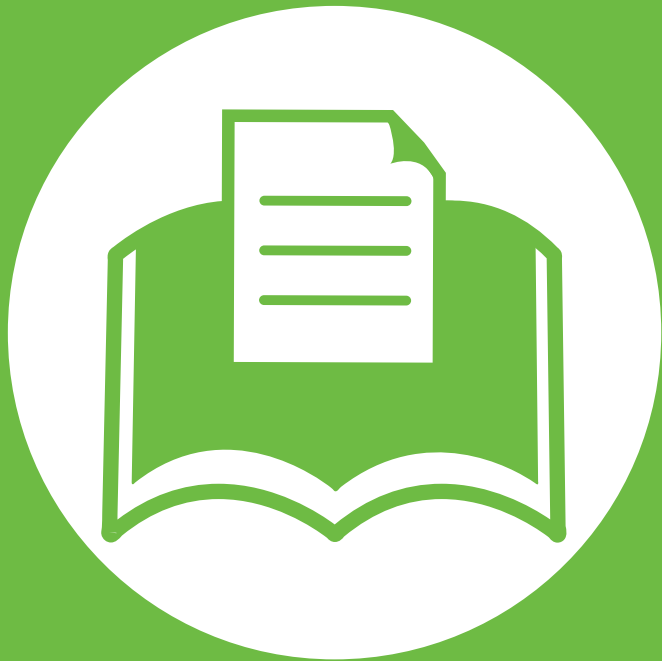

5. Appendix

This chapter provides product specifications and information concerning applicable regulations.

- **Specifications** 83
- **Regulatory information** 93
- **Copyright** 104





General specifications



The specification values listed below are subject to change without notice. See www.samsung.com/printer for possible changes in information.

Items		Description
Dimension	Width x Length x Height	<ul style="list-style-type: none"> • ML-330x/ ML-331xD: 366 x 368 x 240.6 mm (14.40 x 14.48 x 9.47 inches) without optional tray • ML-331xND/ ML-371xD/ ML-371xND/ ML-371xDW: 366 x 368 x 252.9 mm (14.40 x 14.48 x 9.96 inches) without optional tray
	Machine with consumables	<ul style="list-style-type: none"> • ML-330x/ ML-331x Series: 9.74 kg (21.47 lbs) • ML-371x Series: 9.95 kg (21.94 lbs)
Noise Level ^a	Ready mode	26 dB (A)
	Print mode	<ul style="list-style-type: none"> • ML-330x/ ML-331x Series: 51 dB (A) • ML-371x Series: 52 dB (A)
Temperature	Operation	10 to 32°C (50 to 90°F)
	Storage (packed)	-20 to 40°C (-4 to 104°F)
Humidity	Operation	20 to 80% RH
	Storage (packed)	10 to 90% RH

Items		Description
Power rating ^b	110 volt models	AC 110 - 127 V
	220 volt models	AC 220 - 240 V
Power consumption	Average operating mode	Less than 550 W
	Ready mode	Less than 60 W
	Power save mode	Less than 3.5 W
	Power off mode	Less than 0.4 W (0.1 W ^c)
Wireless ^d	Module	U98Z058

a. Sound Pressure Level, ISO 7779. Configuration tested: basic machine installation, A4 paper, simplex printing.

b. See the rating label on the machine for the correct voltage (V), frequency (hertz) and type of current (A) for your machine.

c. For the machine that has a power switch.

d. Wireless model only (see "Features by models" on page 7).



Print media specifications

Type	Size	Dimensions	Print media weight/Capacity ^a	
			Tray1 / Optional tray	Multi-purpose tray ^b
Plain paper	Letter	216 x 279 mm (8.5 x 11 inches)	70 to 90 g/m ² (19 to 24 lbs bond) <ul style="list-style-type: none"> • 250 sheets of 80 g/m² (20 lbs bond) for tray1. • 520 sheets of 80 g/m² (20 lbs bond) for optional tray. 	70 to 90 g/m ² (19 to 24 lbs bond) <ul style="list-style-type: none"> • The machine does not have a display screen: 1 sheet of 80 g/m² (20 lbs bond) • The machine has a display screen: 50 sheets of 80 g/m² (20 lb bond)
	Legal	216 x 356 mm (8.5 x 14 inches)		
	US Folio	216 x 330 mm (8.5 x 13 inches)		
	A4	210 x 297 mm (8.27 x 11.69 inches)		
	Oficio	216 x 343 mm (8.5 x 13.5 inches)		
	JIS B5	182 x 257 mm (7.17 x 10.12 inches)		
	ISO B5	176 x 250 mm (6.93 x 9.84 inches)		
	Executive	184 x 267 mm (7.25 x 10.5 inches)		
	A5	148 x 210 mm (5.83 x 8.27 inches)		
	A6	105 x 148 mm (4.13 x 5.83 inches)	• 150 sheets of 75 g/m ² (20 lbs bond)	

Type	Size	Dimensions	Print media weight/Capacity ^a	
			Tray1 / Optional tray	Multi-purpose tray ^b
Envelope	Envelope Monarch	98 x 191 mm (3.87 x 7.5 inches)	Not available in tray1/optional tray.	75 to 90 g/m ² (20 to 24 lbs bond)
	Envelope No. 10	105 x 241 mm (4.12 x 9.5 inches)		
	Envelope DL	110 x 220 mm (4.33 x 8.66 inches)		
	Envelope C5	162 x 229 mm (6.38 x 9.02 inches)		
	Envelope C6	114 x 162 mm (4.49 x 6.38 inches)		
Thick paper	Refer to the Plain paper section	Refer to the Plain paper section	91 to 105 g/m ² (24 to 28 lbs bond)	91 to 105 g/m ² (24 to 28 lbs bond)
Thicker paper	Refer to the Plain paper section	Refer to the Plain paper section	Not available in tray1/optional tray.	164 to 220 g/m ² (44 to 58 lbs bond)
Thin paper	Refer to the Plain paper section	Refer to the Plain paper section	60 to 70 g/m ² (16 to 19 lbs bond)	60 to 70 g/m ² (16 to 19 lbs bond)
Transparency	Letter, A4	Refer to the Plain paper section	Not available in tray1/optional tray.	138 to 146 g/m ² (36.81 to 38.91 lbs bond)

Type	Size	Dimensions	Print media weight/Capacity ^a	
			Tray1 / Optional tray	Multi-purpose tray ^b
Labels ^c	Letter, Legal, US Folio, A4, JIS B5, ISO B5, Executive, A5	Refer to the Plain paper section	Not available in tray1/optional tray.	120 to 150 g/m ² (32 to 40 lbs bond)
Card stock	Letter, Legal, US Folio, A4, JIS B5, ISO B5, Executive, A5	Refer to the Plain paper section	121 to 163 g/m ² (32 to 43 lbs bond)	121 to 163 g/m ² (32 to 43 lbs bond)
Bond paper	Refer to the Plain paper section	Refer to the Plain paper section	106 to 120 g/m ² (28 to 32 lbs bond)	106 to 120 g/m ² (28 to 32 lbs bond)
Minimum size (custom)		<ul style="list-style-type: none"> • Multi-purpose tray: 76 x 127 mm (3 x 5 inches) • Tray 1: 105 x 148.5 mm (4.13 x 5.85 inches) 	60 to 163 g/m ² (16 to 43 lbs bond) ^{d, e} Not available in optional tray.	
Maximum size (custom)		216 x 356 mm (8.5 x 14 inches)		

a. Maximum capacity may differ depending on media weight, thickness, and environmental conditions.

b. The machine does not have a display screen: 1 sheet for multi-purpose tray.

c. The smoothness of the labels used in this machine is 100 to 250 (sheffield). This means the numeric level of smoothness.

d. The paper types available in multi-purpose tray: Plan, Thick, Thicker, Thin, Cotton, Colored, Pre-printed, Recycled, Envelope, Transparency, Labels, Cardstock, Bond, Archive

e. The paper types available in tray 1: Plan, Thick, Thin, Recycled, Cardstock, Bond, Archive



System requirements

Microsoft® Windows®

Operating system	Requirement (recommended)		
	CPU	RAM	free HDD space
Windows® 2000	Intel® Pentium® II 400 MHz (Pentium III 933 MHz)	64 MB (128 MB)	600 MB
Windows® XP	Intel® Pentium® III 933 MHz (Pentium IV 1 GHz)	128 MB (256 MB)	1.5 GB
Windows Server® 2003	Intel® Pentium® III 933 MHz (Pentium IV 1 GHz)	128 MB (512 MB)	1.25 GB to 2 GB
Windows Server® 2008	Intel® Pentium® IV 1 GHz (Pentium IV 2 GHz)	512 MB (2 GB)	10 GB
Windows Vista®	Intel® Pentium® IV 3 GHz	512 MB (1 GB)	15 GB
Windows® 7	Intel® Pentium® IV 1 GHz 32-bit or 64-bit processor or higher	1 GB (2 GB)	16 GB
	<ul style="list-style-type: none"> • Support for DirectX® 9 graphics with 128 MB memory (to enable the Aero theme). • DVD-R/W Drive 		
Windows Server® 2008 R2	Intel® Pentium® IV 1 GHz (x86) or 1.4 GHz (x64) processors (2 GHz or faster)	512 MB (2 GB)	10 GB



- Internet Explorer 6.0 or higher is the minimum requirement for all Windows operating systems.
- Users who have administrator rights can install the software.

- **Windows Terminal Services** is compatible with your machine.
- For Windows 2000, Services Pack 4 or higher is required.

Macintosh

Operating system	Requirements (Recommended)		
	CPU	RAM	Free HDD space
Mac OS X 10.3 ~ 10.4	<ul style="list-style-type: none">• Intel® processors• PowerPC G4/ G5	<ul style="list-style-type: none">• 128 MB for a powerPC based Mac (512 MB)• 512 MB for an Intel-based Mac (1 GB)	1 GB
Mac OS X 10.5	<ul style="list-style-type: none">• Intel® processors• 867 MHz or faster Power PC G4/ G5	512 MB (1 GB)	1 GB
Mac OS X 10.6	<ul style="list-style-type: none">• Intel® processors	1 GB (2 GB)	1 GB

Linux

Items	Requirements
Operating system	Fedora 4 ~ 12 (32/ 64 bit) OpenSuSE® 10.2, 10.3, 11.0, 11.1, 11.2 (32/64 bit) SuSE 10.0, 10.1 (32 bit) Ubuntu 5.04, 5.10, 6.04, 6.10, 7.04, 7.10, 8.04, 8.10, 9.04, 9.10 (32/64 bit) Mandriva 2005, 2006, 2007, 2008, 2009, 2009.1 (32/64 bit) Debian 4.0, 5.0 (32/64 bit) Redhat® Enterprise Linux WS 4, 5 (32/64 bit) SuSE Linux Enterprise Desktop 10, 11 (32/64 bit)
CPU	Pentium IV 2.4GHz (Intel Core™2)
RAM	512 MB (1 GB)
Free HDD space	1 GB (2 GB)

Unix

Items	Requirements
Operating system	Sun Solaris 9, 10 (x86, SPARC) HP-UX 11.0, 11i v1, 11i v2, 11i v3 (PA-RISC, Itanium) IBM AIX 5.1, 5.2, 5.3, 5.4

Items	Requirements
Free HDD space	Up to 100 MB



Network environment



Network and wireless models only (see "Features by models" on page 7)

You need to set up the network protocols on the machine to use it as your network machine. The following table shows the network environments supported by the machine.

Items	Specifications
Network interface	<ul style="list-style-type: none">• Ethernet 10/100/1000 Base-TX• 802.11b/g/n Wireless LAN
Network operating system	<ul style="list-style-type: none">• Windows 2000/Server 2003 /Server 2008/XP/Vista/7/Server 2008 R2• Various Linux OS• Mac OS X 10.3 ~ 10.6• Unix

Items	Specifications
Network protocols	<ul style="list-style-type: none">• TCP/IPv4• DHCP, BOOTP• DNS, WINS, Bonjour, SLP, UPnP• Standard TCP/IP Printing (RAW), LPR, IPP, WSD• SNMPv 1/2/3, HTTP (S), IPSec• TCP/IPv6 (DHCP, DNS, RAW, LPR, SNMPv 1/2/3, HTTP (S), IPSec)
Wireless security	<ul style="list-style-type: none">• Authentication: Open System, Shared Key, WPA Personal, WPA2 Personal (PSK), WPA Enterprise, WPA2 Enterprise• Encryption: WEP64, WEP128, TKIP, AES

This machine is designed for a normal work environment and certified with several regulatory statements.



Laser safety statement

The printer is certified in the U.S. to conform to the requirements of DHHS 21 CFR, chapter 1 Subchapter J for Class I(1) laser products, and elsewhere is certified as a Class I laser product conforming to the requirements of IEC 60825-1 : 2007.

Class I laser products are not considered to be hazardous. The laser system and printer are designed so there is never any human access to laser radiation above a Class I level during normal operation, user maintenance or prescribed service condition.

Warning

Never operate or service the printer with the protective cover removed from laser/scanner assembly. The reflected beam, although invisible, can damage your eyes.

When using this product, these basic safety precautions should always be followed to reduce risk of fire, electric shock, and injury to persons:



CAUTION - CLASS 3B LASER RADIATION WHEN OPEN
AVOID EXPOSURE TO THE BEAM.
DANGER - LASER RADIATION AVOID DIRECT
EXPOSURE TO BEAM.

DANGER - RADIATIONS INVISIBLES DU LASER EN CAS
D'OUVERTURE. EVITER TOUTE EXPOSITION
DIRECTE AU FAISCEAU.

VORSICHT - UNSICHTBARE LASERSTRAHLUNG, WENN
ABDECKUNG GEÖFFNET.
NICHT DEM STRAHL AUSSETZEN.

ATTENZIONE - RADIAZIONE LASER INVISIBILE IN CASO DI
APERTURA. EVITARE L'ESPOSIZIONE AL FASCIO.

PRECAUCIÓN - RADIACIÓN LASER INVISIBLE CUANDO SE ABRE.
EVITAR EXPONERSE AL RAYO.

PERIGO - RADIAÇÃO LASER INVISÍVEL AO ABRIR. EVITE
EXPOSIÇÃO DIRECTA AO FEIXE.

GEVAAR - ONZICHTBARE LASERSTRALEN BIJ GEOPENDE
KLEP. DEZE KLEP NIET OPENEN.

ADVARSEL - USYNLIG LASERSTRÅLNING VED ÅBNING.
UNDGÅ UDSAETTELSE FOR STRÅLNING.

ADVARSEL - USYNLIG LASERSTRÅLNING NÅR DEKSEL
ÅPNES. UNNGÅ EKSPONERING FOR STRÅLEN.

VARNING - OSYNLIG LASERSTRÅLNING NÅR DENNA DEL
ÄR ÖPPEN. STRÅLEN ÄR FARLIG.

VAROITUS - NÄKYMÄTÖNTÄ LASERSÄTELYÄ AVATTAESSA.
VARO SUORAA ALTISTUMISTA SÄTEELLE.

注意 - 严禁揭开此盖, 以免激光泄露灼伤
주의 - 이 덮개를 열면 레이저광에 노출될 수 있으므로
주의하십시오.



Taiwan only

警告使用者：

此為甲類資訊技術設備，於居住環境中使用時，可能會造成射頻擾動，在此種情況下，使用者會被要求採取某些適當的對策。



Ozone safety



This product's ozone emission rate is under 0.1 ppm. Because ozone is heavier than air, keep the product in a place with good ventilation.



Power saver



This printer contains advanced energy conservation technology that reduces power consumption when it is not in active use.

When the printer does not receive data for an extended period of time, power consumption is automatically lowered.

ENERGY STAR and the ENERGY STAR mark are registered U.S. marks.

For more information on the ENERGY STAR program see <http://www.energystar.gov>



Recycling



Recycle or dispose of the packaging material for this product in an environmentally responsible manner.



China only

回收和再循环

为了保护环境，我公司已经为废弃的产品建立了回收和再循环系统。我们会为您无偿提供回收同类废旧产品的服务。

当您要废弃您正在使用的产品时，请您及时与工厂取得联系，我们会及时为您提供服务。



Correct disposal of this product (Waste electrical & electronic equipment)

(Applicable in the European Union and other European countries with separate collection systems)



This marking on the product, accessories or literature indicates that the product and its electronic accessories (e.g. charger, headset, USB cable) should not be disposed of with other household waste at the end of their working life. To prevent possible harm to the environment or human health from uncontrolled waste disposal, please separate these items from other types of waste and recycle them responsibly to promote the sustainable reuse of material resources.

Household users should contact either the retailer where they purchased this product, or their local government office, for details of where and how they can take these items for environmentally safe recycling.

Business users should contact their supplier and check the terms and conditions of the purchase contract. This product and its electronic accessories should not be mixed with other commercial wastes for disposal.

The United States of America only

Dispose unwanted electronics through an approved recycler. To find the nearest recycling location, go to our website: www.samsung.com/recyclingdirect Or call, (877) 278 - 0799



Radio frequency emissions

FCC information to the user

This device complies with Part 15 of the FCC Rules. Operation is subject to the following two conditions:

- This device may not cause harmful interference, and
- This device must accept any interference received, including interference that may cause undesired operation.

This equipment has been tested and found to comply with the limits for a Class B digital device, pursuant to Part 15 of the FCC Rules.

These limits are designed to provide reasonable protection against harmful interference in a residential installation. This equipment generates, uses and can radiate radio frequency energy and, if not installed and used in accordance with the instructions, may cause harmful interference to radio communications. However, there is no guarantee that interference will not occur in a particular installation. If this equipment does cause harmful interference to radio or television reception, which can be determined by turning the equipment off and on, the user is encouraged to try to correct the interference by one or more of the following measures:

- Reorient or relocate the receiving antenna.
- Increase the separation between the equipment and receiver.
- Connect the equipment into an outlet on a circuit different from that to which the receiver is connected.
- Consult the dealer or experienced radio TV technician for help.



Change or modifications not expressly approved by the manufacturer responsible for compliance could void the user's authority to operate the equipment.

Canadian radio interference regulations

This digital apparatus does not exceed the Class B limits for radio noise emissions from digital apparatus as set out in the interference-causing equipment standard entitled “Digital Apparatus”, ICES-003 of the Industry and Science Canada.

Cet appareil numérique respecte les limites de bruits radioélectriques applicables aux appareils numériques de Classe B prescrites dans la norme sur le matériel brouilleur: “Appareils Numériques”, ICES-003 édictée par l’Industrie et Sciences Canada.



United states of america

Federal communications commission (FCC)

► Intentional emitter per FCC Part 15

Low power, Radio LAN type devices (radio frequency (RF) wireless communication devices), operating in the 2.4 GHz/5 GHz Band, may be present (embedded) in your printer system. This section is only applicable if these devices are present. Refer to the system label to verify the presence of wireless devices.

Wireless devices that may be in your system are only qualified for use in the United States of America if an FCC ID number is on the system label.

The FCC has set a general guideline of 20 cm (8 inches) separation between the device and the body, for use of a wireless device near the body (this does not include extremities). This device should be used more than 20 cm (8 inches) from the body when wireless devices are on. The power output of the wireless device (or devices), which may be embedded in your printer, is well below the RF exposure limits as set by the FCC.

This transmitter must not be collocated or operation in conjunction with any other antenna or transmitter.

Operation of this device is subject to the following two conditions: (1) This device may not cause harmful interference, and (2) this device must accept any interference received, including interference that may cause undesired operation of the device.



Wireless devices are not user serviceable. Do not modify them in any way. Modification to a wireless device will void the authorization to use it. Contact manufacturer for service.

FCC statement for wireless LAN use:



While installing and operating this transmitter and antenna combination the radio frequency exposure limit of 1m W/cm² may be exceeded at distances close to the antenna installed. Therefore, the user must maintain a minimum distance of 20cm from the antenna at all times. This device cannot be collocated with another transmitter and transmitting antenna.



Taiwan only

低功率電波輻射性電機管理辦法

- 第十二條** 經型式認證合格之低功率射頻電機，非經許可，公司、商號或使用者均不得擅自變更頻率、加大功率或變更原設計之特性及功能。
- 第十四條** 低功率射頻電機之使用不得影響飛航安全及干擾合法通信；經發現有干擾現象時，應立即停用，並改善至無干擾時方得繼續使用。前項合法通信，指依電信法規定作業之無線電通信。低功率射頻電機須忍受合法通信或工業、科學及醫療用電波輻射性電機設備之干擾。



Russia only



AB57



Germany only

Das Gerät ist nicht für die Benutzung am Bildschirmarbeitsplatz gemäß BildschirmV vorgesehen.



Turkey only

- **RoHS**

EEE Yönetmeliğine Uygundur.
This EEE is compliant with RoHS.

- Bu ürünün ortalama yaşam süresi 7 yıl, garanti süresi 2 yıldır.



Replacing the fitted plug (for UK only)

Important

The mains lead for this machine is fitted with a standard (BS 1363) 13 amp plug and has a 13 amp fuse. When you change or examine the fuse, you must re-fit the correct 13 amp fuse. You then need to replace the fuse cover. If you have lost the fuse cover, do not use the plug until you have another fuse cover.

Contact the people from you purchased the machine.

The 13 amp plug is the most widely used type in the UK and should be suitable. However, some buildings (mainly old ones) do not have normal 13 amp plug sockets. You need to buy a suitable plug adaptor. Do not remove the moulded plug.



If you cut off the moulded plug, get rid of it straight away.

You cannot rewire the plug and you may receive an electric shock if you plug it into a socket.

Important warning:



You must earth this machine.

The wires in the mains lead have the following color code:

- **Green and Yellow:** Earth
- **Blue:** Neutral
- **Brown:** Live

If the wires in the mains lead do not match the colors marked in your plug, do the following:

You must connect the green and yellow wire to the pin marked by the letter “E” or by the safety ‘Earth symbol’ or colored green and yellow or green.

You must connect the blue wire to the pin which is marked with the letter “N” or colored black.

You must connect the brown wire to the pin which is marked with the letter “L” or colored red.

You must have a 13 amp fuse in the plug, adaptor, or at the distribution board.



Declaration of conformity (European countries)

Approvals and Certifications



Hereby, Samsung Electronics, declares that this [ML-371xDW] is in compliance with the essential requirements and other relevant provisions of R&TTE Directive 1999/5/EC.

Hereby, Samsung Electronics, declares that this [ML-330x Series, ML-331x Series, ML-371x Series] is in compliance with the essential requirements and other relevant provisions of Low Voltage Directive (2006/95/EC), EMC Directive (2004/108/EC).

The declaration of conformity may be consulted at www.samsung.com/printer, go to Support > Download center and enter your printer (MFP) name to browse the EuDoC.

January 1, 1995: Council Directive 2006/95/EC Approximation of the laws of the member states related to low voltage equipment.

January 1, 1996: Council Directive 2004/108/EC, approximation of the laws of the Member States related to electromagnetic compatibility.

March 9, 1999: Council Directive 1999/5/EC on radio equipment and telecommunications terminal equipment and the mutual recognition of their conformity. A full declaration, defining the relevant Directives and referenced standards can be obtained from your Samsung Electronics Co., Ltd. representative.

EC Certification

Certification to 1999/5/EC Radio Equipment & Telecommunications Terminal Equipment Directive (FAX)

This Samsung product has been self-certified by Samsung for pan-European single terminal connection to the analogue public switched telephone network (PSTN) in accordance with Directive 1999/5/EC. The product has been designed to work with the national PSTNs and compatible PBXs of the European countries:

In the event of problems, you should contact the Euro QA Lab of Samsung Electronics Co., Ltd. in the first instance.

The product has been tested against TBR21. To assist in the use and application of terminal equipment which complies with this standard, the European Telecommunication Standards Institute (ETSI) has issued an advisory document (EG 201 121) which contains notes and additional requirements to ensure network compatibility of TBR21 terminals. The product has been designed against, and is fully compliant with, all of the relevant advisory notes contained in this document.

European radio approval information (for products fitted with EU-approved radio devices)

Low power, Radio LAN type devices (radio frequency (RF) wireless communication devices), operating in the 2.4 GHz/5 GHz band, may be present (embedded) in your printer system which is intended for home or office use. This section is only applicable if these devices are present. Refer to the system label to verify the presence of wireless devices.

CE0984

Wireless devices that may be in your system are only qualified for use in the European Union or associated areas if a CE mark with a Notified Body Registration Number and the Alert Symbol is on the system label.

The power output of the wireless device or devices that may be embedded in you printer is well below the RF exposure limits as set by the European Commission through the R&TTE directive.

► European states qualified under wireless approvals:

EU countries

► European states with restrictions on use:

EU

In France, the frequency range is restricted to 2454-2483.5 MHz for devices above 10 mW transmitting power such as wireless

EEA/EFTA countries

No limitations at this time



Regulatory compliance statements

Wireless guidance

Low power, Radio LAN type devices (radio frequency (RF) wireless communication devices), operating in the 2.4 GHz/5 GHz Band, may be present (embedded) in your printer system. The following section is a general overview of considerations while operating a wireless device.

Additional limitations, cautions, and concerns for specific countries are listed in the specific country sections (or country group sections). The wireless devices in your system are only qualified for use in the countries identified by the Radio Approval Marks on the system rating label. If the country you will be using the wireless device in, is not listed, contact your local Radio Approval agency for requirements. Wireless devices are closely regulated and use may not be allowed.

The power output of the wireless device or devices that may be embedded in your printer is well below the RF exposure limits as known at this time. Because the wireless devices (which may be embedded into your printer) emit less energy than is allowed in radio frequency safety standards and recommendations, manufacturer believes these devices are safe for use. Regardless of the power levels, care should be taken to minimize human contact during normal operation.

As a general guideline, a separation of 20 cm (8 inches) between the wireless device and the body, for use of a wireless device near the body (this does not include extremities) is typical. This device should be used more than 20 cm (8 inches) from the body when wireless devices are on and transmitting.

This transmitter must not be collocated or operation in conjunction with any other antenna or transmitter.

Some circumstances require restrictions on wireless devices. Examples of common restrictions are listed below:



Radio frequency wireless communication can interfere with equipment on commercial aircraft. Current aviation regulations require wireless devices to be turned off while traveling in an airplane. IEEE 802.11 (also known as wireless Ethernet) and Bluetooth communication devices are examples of devices that provide wireless communication.



In environments where the risk of interference to other devices or services is harmful or perceived as harmful, the option to use a wireless device may be restricted or eliminated. Airports, Hospitals, and Oxygen or flammable gas laden atmospheres are limited examples where use of wireless devices may be restricted or eliminated. When in environments where you are uncertain of the sanction to use wireless devices, ask the applicable authority for authorization prior to use or turning on the wireless device.



Every country has different restrictions on the use of wireless devices. Since your system is equipped with a wireless device, when traveling between countries with your system, check with the local Radio Approval authorities prior to any move or trip for any restrictions on the use of a wireless device in the destination country.



If your system came equipped with an internal embedded wireless device, do not operate the wireless device unless all covers and shields are in place and the system is fully assembled.



Wireless devices are not user serviceable. Do not modify them in any way. Modification to a wireless device will void the authorization to use it. Contact manufacturer for service.



Only use drivers approved for the country in which the device will be used. See the manufacturer System Restoration Kit, or contact manufacturer Technical Support for additional information.



Israel only

מספר אישור אלחוטי של משרד התקשורת 51-24146
אסור להחליף את האנטנה המקורית של המכשיר ולא
לעשות בו כל שינוי טכני אחר



China only

产品中有毒有害物质或元素的名称及含量

部件名称	有毒有害物质或元素					
	铅 (Pb)	汞 (Hg)	镉 (Cd)	六价铬 (Cr ⁶⁺)	多溴联苯 (PBB)	多溴联苯醚 (PBDE)
塑料	○	○	○	○	○	○
金属 (机箱)	X	○	○	○	○	○
印刷电路部件 (PCA)	X	○	○	○	○	○
电缆 / 连接器	X	○	○	○	○	○
电源设备	X	○	○	○	○	○
电源线	X	○	○	○	○	○
机械部件	X	○	○	○	○	○
卡盒部件	X	○	○	○	○	○
定影部件	X	○	○	○	○	○
扫描仪部件 - CCD (如果有)	X	X	○	○	○	○
扫描仪部件 - 其它 (如果有)	X	○	○	○	○	○
印刷电路板部件 (PBA)	X	○	○	○	○	○
墨粉	○	○	○	○	○	○
滚筒	○	○	○	○	○	○

○：表示该有毒有害物质在该部件所有均质材料中的含量均在 SJ/T 11363-2006 标准规定的限量要求以下。

×：表示该有毒有害物质至少在该部件的某一均质材料中的含量超出 SJ/T 11363-2006 标准规定的限量要求。

以上表为目前本产品含有有毒有害物质的信息。本信息由本公司的配套厂家提供，经本公司审核后而做成，本产品的部分部件含有有毒有害物质，这些部件是在现有科学技术水平下暂时无可替代物质，但三星电子将会一直为满足 SJ/T 11363-2006 标准而做不懈的努力。

© 2010 Samsung Electronics Co., Ltd. All rights reserved.

This user's guide is provided for information purposes only. All information included herein is subject to change without notice.

Samsung Electronics is not responsible for any direct or indirect damages, arising from or related to use of this user's guide.

- Samsung and the Samsung logo are trademarks of Samsung Electronics Co., Ltd.
- Microsoft, Windows, Windows Vista, Windows 7, and Windows Server 2008 R2 are either registered trademarks or trademarks of Microsoft Corporation.
- TrueType, LaserWriter, and Macintosh are trademarks of Apple Computer, Inc.
- All other brand or product names are trademarks of their respective companies or organizations.

Refer to the '**LICENSE.txt**' file in the provided CD-ROM for the open source license information.

REV. 1.08

A				
accessories				
ordering	52			
C				
cleaning				
inside	62			
outside	62			
pickup roller	64			
cleaning a machine	62			
control panel	19			
convention	9			
D				
default settings				
tray setting	42			
display screen	20, 21			
E				
eco button	19, 20, 21			
eco printing	46			
error message	77			
F				
favorites settings, for printing	45			
		features	5	
		print media feature	85	
		front view	17	
		G		
		general icons	9	
		J		
		jam		
		clearing paper	68	
		tips for avoiding paper jams	67	
		L		
		Linux		
		system requirements	90	
		loading		
		paper in multi-purpose tray	35	
		paper in the tray1	33	
		special media	37	
		local		
		driver installation	23	
		driver reinstalling	24	
		M		
		Macintosh		
		system requirements	89	
		maintenance parts	53	
		memory		
		installing memory module	58	
		memory upgrading	58	
		menu overview	28	
		multi-purpose tray		
		loading	35	
		tips on using	35	
		using special media	37	
		N		
		network		
		installing environment	91	
		O		
		optional tray	52	
		loading paper	33	
		ordering	52	
		P		
		Parallel		
		ordering	52	
		print media		
		card stock	41	
		envelope	38	
		labels	40	

output support	85	replacing toner cartridge	56
preprinted paper	42		
setting the paper size	42	T	
setting the paper type	42	<hr/>	
special media	37	toner cartridge	
transparency	40	redistributing toner	54
Printing	43	replacing the cartridge	56
printing		tray	
printing a document		adjusting the width and length	32
Windows	43	changing the tray size	32
R		loading paper in multi-purpose tray	35
<hr/>		ordering an optional tray	52
rear view	18	setting the paper size and type	42
regulatory information	93	U	
S		<hr/>	
<hr/>		understanding the status LED	74
safety		Unix	
information	10	system requirements	90
symbols	10	using help	46
specifications	83	W	
print media	85	<hr/>	
stop button	19, 20, 21	Windows	
supplies		driver installation for USB cable connected	23, 24
available supplies	51	system requirements	88
monitoring the supplies life	60		
ordering	51		

ML-330x Series
ML-331x Series
ML-371x Series

User's Guide Advanced

imagine the possibilities

This guide provides information about installation, advanced configuration, operation and troubleshooting on various OS environments.

Some features may not be available depending on model or country.



1. Software installation

- 5 Installation for Macintosh
- 7 Reinstallation for Macintosh
- 8 Installation for Linux
- 10 Reinstallation for Linux



2. Using a network-connected

- 12 Useful network programs
- 13 Wired network setup
- 17 Installing driver over the network
- 24 IPv6 configuration
- 27 Wireless network setup



3. Useful setting menus

- 56 Information
- 57 Layout
- 58 Paper
- 59 Graphic
- 60 System setup

- 63 Emulation
- 64 Network
- 65 Admin setup



4. Special features

- 67 Altitude adjustment
- 68 Changing the font setting
- 69 Changing the default print settings
- 70 Setting your machine as a default machine
- 71 Using advanced print features
- 79 Using Direct Printing Utility (Windows only)
- 81 Using memory/hard drive features
- 83 Macintosh printing
- 85 Linux printing
- 87 Unix printing



5. Maintenance

- 90 Storing the toner cartridge
- 92 Tips for moving & storing your machine
- 93 Useful management tools



6. Troubleshooting

- 105 Paper feeding problems
- 106 Power and cable connecting problems
- 107 Printing problems
- 111 Printing quality problems
- 119 Operating system problems

Contact SAMSUNG worldwide

Glossary

1. Software installation



This chapter provides instructions for installing essential and helpful software for use in an environment where the machine is connected via a cable. A locally connected machine is a machine directly attached to your computer using the cable. If your machine is attached to a network, skip the following steps below and go on to installing a network connected machine's driver (see [Installing driver over the network](#)¹⁷).

- **Installation for Macintosh** **5**
- **Reinstallation for Macintosh** **7**
- **Installation for Linux** **8**
- **Reinstallation for Linux** **10**



- If you are a Windows OS user, refer to the Basic Guide for installing the machine's driver.
- Only use a USB cable no longer than 3 meter (118 inches).

- 1 Make sure that the machine is connected to your computer and powered on.
- 2 Insert the supplied software CD into your CD-ROM drive.
- 3 Double-click the CD-ROM icon that appears on your Macintosh desktop.
- 4 Double-click the **MAC_Installer** folder > **Installer OS X** icon.
- 5 Enter the password and click **OK**.
- 6 Click **Continue**.
- 7 Read the license agreement and click **Continue**.
- 8 Click **Agree** to agree to the license agreement.
- 9 Select **Easy Install** and click **Install**. **Easy Install** is recommended for most users. All components necessary for machine operations will be installed.
If you select **Custom Install**, you can choose individual components to install.
- 10 When the message that warns that all applications will close on your computer appears, click **Continue**.
- 11 Select **Typical installation for a local printer** and then click **OK**.
- 12 Click **Continue** on the **Read Me** window.
- 13 After the installation is finished, click **Quit**.
- 14 Open the **Applications** folder > **Utilities** > **Print Setup Utility**.
 - For Mac OS X 10.5-10.6, open the **Applications** folder > **System Preferences** and click **Print & Fax**.
- 15 Click **Add** on the **Printer List**.
 - For Mac OS X 10.5-10.6, click the “+” icon; a display window will pop up.
- 16 For Mac OS X 10.3, select the **USB** tab.
 - For Mac OS X 10.4, click **Default Browser** and find the USB connection.
 - For Mac OS X 10.5-10.6, click **Default** and find the USB connection.

17 For Mac OS X 10.3, if Auto Select does not work properly, select **Samsung** in **Printer Model** and your machine name in **Model Name**.

- For Mac OS X 10.4, if Auto Select does not work properly, select **Samsung** in **Print Using** and your machine name in **Model**.
- For Mac OS X 10.5-10.6, if Auto Select does not work properly, select **Select a driver to use...** and your machine name in **Print Using**.

Your machine appears on the **Printer List**, and is set as the default machine.

18 Click **Add**.

If the printer driver does not work properly, uninstall the driver and reinstall it.

- 1 Make sure that the machine is connected to your computer and powered on.
- 2 Insert the supplied software CD into your CD-ROM drive.
- 3 Double-click the CD-ROM icon that appears on your Macintosh desktop.
- 4 Double-click the **MAC_Installer** folder > **Installer OS X** icon.
- 5 Enter the password and click **OK**.
- 6 Click **Continue**.
- 7 Read the license agreement and click **Continue**.
- 8 Click **Agree** to agree to the license agreement.
- 9 Select **Uninstall** and click **Uninstall**.
- 10 When the message which warns that all applications will close on your computer appears, click **Continue**.
- 11 When the uninstall is done, click **Quit**.



If a machine has already been added, delete it from the **Print Setup Utility** or **Print & Fax**.

You need to download Linux software packages from the Samsung website to install the printer software (<http://www.samsung.com/printer>).



Installing the Unified Linux Driver

- 1 Make sure that the machine is connected to your computer and powered on.
- 2 When the **Administrator Login** window appears, type “root” in the **Login** field and enter the system password.



You must log in as a super user (root) to install the machine software. If you are not a super user, ask your system administrator.

- 3 From the Samsung website, download the Unified Linux Driver package to your computer.
- 4 Right-click the **Unified Linux Driver** package and extract the package.
- 5 Double click **cdroot > autorun**.

- 6 When the welcome screen appears, click **Next**.
- 7 When the installation is complete, click **Finish**.

The installation program added the Unified Driver Configurator desktop icon and the Unified Driver group to the system menu for your convenience. If you have any difficulties, consult the on-screen help that is available through your system menu or from the driver package Windows applications, such as **Unified Driver Configurator** or **Image Manager**.



Installing the Smart Panel

- 1 Make sure that the machine is connected to your computer and powered on.
- 2 When the **Administrator Login** window appears, type in root in the **Login** field and enter the system password.



You must log in as a super user (root) to install the machine software. If you are not a super user, ask your system administrator.

- 3 From the Samsung website, download the **Smart Panel** package to your computer.

4 Right-click the Smart Panel package and extract the package.

5 Double click **cdroot > Linux > smartpanel > install.sh**.



Installing the Printer Settings Utility

1 Make sure that the machine is connected to your computer and powered on.

2 When the **Administrator Login** window appears, type “root” in the **Login** field and enter the system password.



You must log in as a super user (root) to install the machine software. If you are not a super user, ask your system administrator.

3 From the Samsung website, download the Printer Settings Utility package to your computer.

4 Right-click the **Printer Settings Utility** package and extract the package.

5 Double click **cdroot > Linux > psu > install.sh**.

If the printer driver does not work properly, uninstall the driver and reinstall it.

- 1 Make sure that the machine is connected to your computer and powered on.
- 2 When the **Administrator Login** window appears, type “root” in the **Login** field and enter the system password.

You must log in as a super user (root) to uninstall the printer driver. If you are not a super user, ask your system administrator.
- 3 Click the icon at the bottom of the desktop. When the Terminal screen appears, type in the following.

```
[root@localhost root]#cd /opt/Samsung/mfp/uninstall/  
[root@localhost uninstall]#./uninstall.sh
```
- 4 Click **Uninstall**.
- 5 Click **Next**.
- 6 Click **Finish**.



2. Using a network-connected machine

This chapter gives you step-by-step instructions for setting up a network connected machine and software.

- **Useful network programs** 12
- **Wired network setup** 13
- **Installing driver over the network** 17
- **IPv6 configuration** 24
- **Wireless network setup** 27

There are several programs available to setup the network settings easily in a network environment. For the network administrator especially, managing several machines on the network is possible.



Before using the programs below, set the IP address first.



SyncThru™ Web Service

The web server embedded on your network machine allows you to do the following tasks (see "Using SyncThru™ Web Service" on page 26):

- Check the supplies information and status.
- Customize machine settings.
- Set the email notification option. When you set this option, the machine status (toner cartridge shortage or machine error) will be sent to a certain person's email automatically.
- Configure the network parameters necessary for the machine to connect to various network environments.



SyncThru™ Web Admin Service

Web-based machine management solution for network administrators. SyncThru™ Web Admin Service provides you with an efficient way of managing network devices and lets you remotely monitor and troubleshoot network machines from any site with corporate internet access. Download this program from <http://solution.samsungprinter.com>.



SetIP

This utility program allows you to select a network interface and manually configure the IP addresses for use with the TCP/IP protocol.

- See "IPv4 configuration using SetIP (Windows)" on page 13.
- See "IPv4 configuration using SetIP (Macintosh)" on page 14.
- See "IPv4 configuration using SetIP (Linux)" on page 15.



TCP/IPv6 is not supported by this program.

You must set up the network protocols on your machine to use it on your network.



You can use network after connecting network cable to a corresponding port on your machine.

- For models that do not have the display screen on the control panel, use the SyncThru™ Web Service or SetIP program.
 - See "Using SyncThru™ Web Service" on page 93.
 - See "Setting IP address" on page 13.
- For models that have the display screen on the control panel, configure the network setting by pressing  (**Menu**) button > **Network** on the control panel (see "Network" on page 64).



Printing a network configuration report

You can print **Network Configuration Report** from the machine's control panel that will show the current machine's network settings. This will help you to set up a network.

- **The machine has the display screen:** Press the  (**Menu**) button on the control panel and select **Network > Network Config. (Network Configuration) > Yes**.
- **The machine does not have the display screen:** Press the  (**Cancel** or **Stop/Clear**) button for more than five seconds on the control panel.

Using this **Network Configuration Report**, you can find your machine's MAC address and IP address.

For example:

- MAC Address: 00:15:99:41:A2:78
- IP Address: 192.0.0.192



Setting IP address

First, you have to set up an IP address for network printing and managements. In most cases a new IP address will be automatically assigned by a DHCP (Dynamic Host Configuration Protocol) server located on the network.

IPv4 configuration using SetIP (Windows)

Before using the SetIP program, disable the computer firewall from **Control Panel > Security Center > Windows Firewall**.

- 1 Install this program from the supplied CD-ROM by double-click **Application > SetIP > Setup.exe**.
- 2 Follow the instructions in the installation window.
- 3 Connect your machine to the network with a network cable.

- 4 Turn on the machine.
- 5 From the Windows **Start** menu, select **All Programs > Samsung Printers > SetIP > SetIP**.
- 6 Click the  icon (third from left) in the SetIP window to open the TCP/IP configuration window.
- 7 Enter the machine's new information into the configuration window as follows. In a corporate intranet, you may need to have this information assigned by a network manager before proceeding.

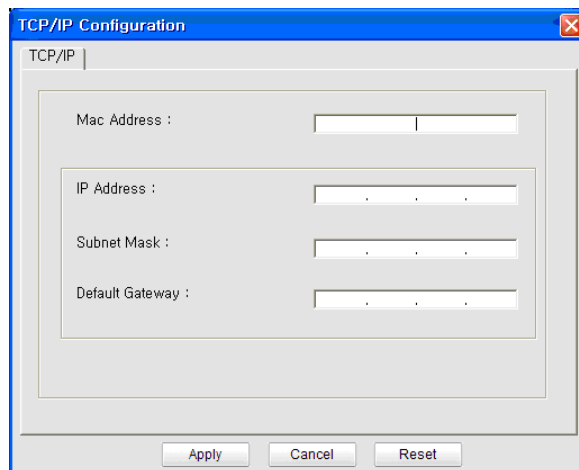

Find the machine's MAC address from the **Network Configuration Report** (see "Printing a network configuration report" on page 13) and enter it without the colons. For example, 00:15:99:29:51:A8 becomes 0015992951A8.

- 8 Click **Apply**, and then click **OK**. The machine will automatically print the **Network Configuration Report**. Confirm that all the settings are correct.

IPv4 configuration using SetIP (Macintosh)

Before using the SetIP program, disable the computer firewall from **System Preferences > Security > Firewall**.



The following instructions may vary from your model.

- 1 Connect your machine to the network with a network cable.
- 2 Insert the Installation CD-ROM, and open the disk window, select **MAC_Installer > MAC_Printer > SetIP > SetIP.ppplet.html**.

- 3 Double-click the file and **Safari** will automatically open, then select **Trust**. The browser will open the **SetIPApplet.html** page that shows the printer's name and IP address information.
- 4 Click the  icon (third from left) in the SetIP window to open the TCP/IP configuration window.
- 5 Enter the machine's new information into the configuration window. In a corporate intranet, you may need to have this information assigned by a network manager before proceeding.



Find the machine's MAC address from the **Network Configuration Report** (see "Printing a network configuration report" on page 13) and enter it without the colons. For example, 00:15:99:29:51:A8 becomes 0015992951A8.

- 6 Select **Apply**, then **OK**, and **OK** again.
- 7 Quit **Safari**.

IPv4 configuration using SetIP (Linux)

Before using the SetIP program, disable the computer firewall from **System Preferences** or **Administrator**.



The following instructions may vary from your model or operating systems.

- 1 Open **/opt/Samsung/mfp/share/utils/**.
- 2 Double-click the **SetIPApplet.html** file.
- 3 Click to open the TCP/IP configuration window.
- 4 Enter the machine's new information into the configuration window. In a corporate intranet, you may need to have this information assigned by a network manager before proceeding.



Find the machine's MAC address from the **Network Configuration Report** (see "Printing a network configuration report" on page 13) and enter it without the colons. For example, 00:15:99:29:51:A8 becomes 0015992951A8.

- 5 The machine will automatically print the **Network Configuration Report**.



Windows

- 1 Make sure that the machine is connected to the network and powered on. Also, your machine's IP address should have been set (see "Setting IP address" on page 13).



If the "**Found New Hardware Wizard**" appears during the installation procedure, click **Cancel** to close the window.

- 2 Insert the supplied software CD into your CD-ROM drive.
The software CD should automatically run and an installation window will appear.

- 3 Select **Install Now**.



When you click the **Advanced Installation**, you can use the **Custom Installation** option. The **Custom Installation** allows you to select the machine's connection and choose individual components to install. Follow the instructions on the window.

- 4 Read **License Agreement**, and select **I accept the terms of the License Agreement**. Then, click **Next**.

The program searches for the machine.



If your machine is not found on the network or locally, an error message appears.

- **Check if you want to install the software without connection of the printer.**
 - Check this option to install this program without a machine connected. In this case, the print a test page window will be skipped, and completes the installation.
- **Search again**

When you press this button, the firewall notice window appears.

 - Turn off the firewall and **Search again**. For Windows operating system, click **Start > Control Panel > Windows Firewall**, and inactivate this option.
 - Turn off the firewall from the third party's program beside the operating system. Refer to the manual provided by individual programs.

- **Direct Input**

The **Direct Input** allows you to search for a specific machine on the network.

- **Search by IP address:** Enter the IP address or the host name. Then click **Next**.

To verify your machine's IP address, print a network configuration report (see "Printing a network configuration report" on page 13).

- **Search by network path:** To find a shared machine (UNC Path), enter the shared name manually or find a shared printer by clicking the **Browse** button. Then click **Next**.

- **Help**

If your machine is not connected to the computer or network, this help button gives detailed information about how to connect the machine.

- **SNMP Community Name**

If your system administrator set the new **SNMP Community Name** on the machine, you can find the machine in the network. Contact your system administrator for new **SNMP Community Name**.

- 5 The searched machines will be shown on the screen. Select the one you wish to use and click **OK**.



If the driver searched only one machine, the confirmation window appears.

- 6 Follow the instructions in the installation window.



Macintosh

- 1 Make sure that the machine is connected to your network and powered on. Also, your machine's IP address should have been set (see "Setting IP address" on page 13).
- 2 Insert the supplied software CD into your CD-ROM drive.
- 3 Double-click the CD-ROM icon that appears on your Macintosh desktop.
- 4 Double-click the **MAC_Installer** folder > **Installer OS X** icon.
- 5 Enter the password and click **OK**.
- 6 Click **Continue**.
- 7 Read the license agreement and click **Continue**.

- 8 Click **Agree** to agree to the license agreement.
- 9 Select **Easy Install** and click **Install**. **Easy Install** is recommended for most users. All components necessary for machine operations will be installed.

If you select **Custom Install**, you can choose individual components to install.
- 10 When the message which warns that all applications will close on your computer appears, click **Continue**.
- 11 Select **Typical installation for a network printer** and then click **OK**.
- 12 The SetIP program automatically runs.
- 13 Click **OK** to continue the installation.
- 14 Click **Continue** on the **Read me** window.
- 15 After the installation is finished, click **OK**.

- 16 Open the **Applications** folder > **Utilities** > **Print Setup Utility**.
 - For Mac OS X 10.5-10.6, open the **Applications** folder > **System Preferences** and click **Print & Fax**.
- 17 Click **Add** on the **Printer List**.
 - For Mac OS X 10.5-10.6, click the “+” icon. A display window will pop up.
- 18 For Mac OS X 10.3, select the **IP Printing** tab.
 - For Mac OS X 10.4, click **IP Printer**.
 - For Mac OS X 10.5-10.6, click **IP**.
- 19 Select **HP Jetdirect - Socket** in **Protocol**.



When printing a document containing many pages, printing performance may be enhanced by choosing **Socket** for **Printer Type** option.

- 20 Enter the machine's IP address in the **Address** input field.
- 21 Enter the queue name in the **Queue** input field. If you cannot determine the queue name for your machine server, try using the default queue first.

22 For Mac OS X 10.3, if Auto Select does not work properly, select **Samsung** in **Printer Model** and your machine name in **Model Name**.

- For Mac OS X 10.4, if Auto Select does not work properly, select **Samsung** in **Print Using** and your machine name in **Model**.
- For Mac OS X 10.5-10.6, if Auto Select does not work properly, choose **Select Printer Software** and your machine name in **Print Using**.

23 Click **Add**.

Your machine appears in the **Printer List**, and is set as the default machine.



Linux

You need to download Linux software packages from the Samsung website to install the printer software (<http://www.samsung.com/printer>).



To install other software:

- See "Installing the Smart Panel" on page 8.
- See "Installing the Printer Settings Utility" on page 9.

Install the Linux driver and add network printer

- 1** Make sure that the machine is connected to your network and powered on. Also, your machine's IP address should have been set.
- 2** Download the Unified Linux Driver package from the Samsung website.
- 3** Extract the UnifiedLinuxDriver.tar.gz file and open the new directory.
- 4** Double-click the **Linux** folder > **install.sh** icon.
- 5** The Samsung installer window opens. Click **Continue**.
- 6** The add printer wizard window opens. Click **Next**.
- 7** Select network printer and click **Search** button.
- 8** The machine's IP address and model name appears on list field.
- 9** Select your machine and click **Next**.
- 10** Input the printer description and **Next**.

11 After the machine is added, click **Finish**.

12 When installation is done, click **Finish**.

Add a network printer

- 1** Double-click the **Unified Driver Configurator**.
- 2** Click **Add Printer**.
- 3** The **Add printer wizard** window opens. Click **Next**.
- 4** Select **Network printer** and click the **Search** button.
- 5** The printer's IP address and model name appears on list field.
- 6** Select your machine and click **Next**.
- 7** Enter the printer description and click **Next**.
- 8** After the machine is added, click **Finish**.



UNIX



Make sure your machine supports the UNIX operating system before installing the UNIX printer driver (see basic guide)

To use the UNIX printer driver, you have to install the UNIX printer driver package first, then setup the printer. You can download the UNIX printer driver package from the Samsung website.

Installing the UNIX printer driver package

The installation procedure is common for all variants of UNIX OS mentioned.

- 1** From the Samsung website, download and unpack the UNIX Printer Driver package to your computer.
- 2** Acquire root privileges.
su -
- 3** Copy the appropriate driver archive to the target UNIX computer.



See administration guide of your UNIX OS for details.

- 4 Unpack the UNIX printer driver package archive.
For example, on IBM AIX uses the following commands.

```
cd /tmp
```

```
gzip -dc /cdrom/unix/packages/aix_power/  
aix_power.tar.gz | tar -xvf -
```

The “**binaries**” folder consists of **binz**, **install**, **share** files and folders.

- 5 Copy the “**binaries**” folder to any local folder.

- 6 Change to the driver’s “**binaries**” directory.

```
cd aix_power/binaries
```

- 7 Run the install script.

```
./install
```

install is the installer script file which is used to install or uninstall the UNIX Printer Driver package.

Use “**chmod 755 install**” command to give the permission to the installer script.

- 8 Execute the “**./install -c**” command to verify installation results.

- 9 Run ‘**installprinter**’ from the command line. This will bring up the **Add Printer Wizard** window. Setup the printer in this window referring to the following procedures.



On some UNIX OS, for example on Solaris 10, just added printers may not be enabled and/or may not accept jobs. In this case run the following two commands on the root terminal:

```
accept <printer_name>
```

```
enable <printer_name>
```

Uninstalling the printer driver package



The utility should be used to delete the printer installed in the system.

- a Run “**uninstallprinter**” command from the terminal.
It will open the **Uninstall Printer Wizard**.
The installed printers are listed in the drop-down list.
- b Select the printer to be deleted.
- c Click **Delete** to delete the printer from the system.

- d Execute the “`./install -d`” command to uninstall the whole package.
- e To verify removal results, execute the “`./install -c`” command.

To re-install it, use the command “`./install`” to reinstall the binaries.

Setting up the printer

To add the printer to your UNIX system, run ‘installprinter’ from the command line. This will bring up the Add Printer Wizard window. Setup the printer in this window according to the following steps:

- 1 Type the name of the printer.
- 2 Select the appropriate printer model from the model list.
- 3 Enter any description corresponding to the type of the printer in the **Type** field. This is optional.
- 4 Specify any printer description in the **Description** field. This is optional.
- 5 Specify the printer location in the **Location** field.
- 6 Type the IP address or DNS name of the printer in the **Device** textbox for network-connected printers. On IBM AIX with **jetdirect Queue type**, only the DNS name is possible-numeric IP address is not allowed.
- 7 **Queue type** shows the connection as **lpd** or **jetdirect** in the corresponding list box. Additionally, **usb** type is available on Sun Solaris OS.
- 8 Select **Copies** to set the number of copies.
- 9 Check the **Collate** option to receive copies already sorted.
- 10 Check the **Reverse Order** option to receive copies in the reverse order.
- 11 Check the **Make Default** option to set this printer as default.
- 12 Click **OK** to add the printer.



IPv6 is supported properly only in Windows Vista or higher.



If the IPv6 network seems to not be working, set all the network setting to the factory defaults and try again using **Clear Setting** (see "Network" on page 64).

In the IPv6 network environment, follow the next procedure to use the IPv6 address.

- 1 Connect your machine to the network with a network cable.
- 2 Turn on the machine.
- 3 Print a **Network Configuration Report** that will check IPv6 addresses (see "Printing a network configuration report" on page 13).
- 4 Select **Start > Control Panel > Printers and Faxes**.
- 5 Click **Add a printer** in the left pane of the **Printers and Faxes** windows.
- 6 Click **Add a local printer** in the **Add Printer** windows.

- 7 The **Add Printer Wizard** window appears. Follow the instructions in the window.



If the machine does not work in the network environment, activate IPv6. Refer to the next section followed by.



Activating IPv6

- 1 Press the  (**Menu**) button on the control panel.
- 2 Press **Network > TCP/IP (IPv6) > IPv6 Activate**.
- 3 Select **On** and press **OK**.
- 4 Turn the machine off and turn it on again.
- 5 Reinstall your printer driver.



Setting IPv6 addresses

The machine supports the following IPv6 addresses for network printing and managements.

- **Link-local Address:** Self-configured local IPv6 address (Address starts with FE80).
- **Stateless Address:** Automatically configured IPv6 address by a network router.
- **Stateful Address:** IPv6 address configured by a DHCPv6 server.
- **Manual Address:** Manually configured IPv6 address by a user.

DHCPv6 address configuration (Stateful)

If you have a DHCPv6 server on your network, you can set one of the following options for default dynamic host configuration.

- 1 Press the  (**Menu**) button on the control panel.
- 2 Press **Network > OK > TCP/IP (IPv6) > OK > DHCPv6 Config.**

- 3 Press **OK** to select the required value you want.
 - **DHCPv6 Addr.:** Always use DHCPv6 regardless of router request.
 - **DHCPv6 Off:** Never use DHCPv6 regardless of router request.
 - **Router:** Use DHCPv6 only when requested by a router.

Manual address configuration

- 1 Start a web browser, such as Internet Explorer, that supports IPv6 addressing as a URL.
- 2 When the **SyncThru™ Web Service** window opens, move the mouse cursor over the **Settings** of the top menu bar and then click **Network Settings**.
- 3 Click **TCP/IPv6** on the left pane of the website.
- 4 Select the **Manual Address** check box. Then, the **Address/Prefix** text box is activated.
- 5 Enter the rest of the address (e.g.,.3FFE:10:88:194::**AAAA**. "A" is the hexadecimal 0 through 9, A through F).
- 6 Click the **Apply** button.



Using SyncThru™ Web Service

- 1 Start a web browser, such as Internet Explorer, that supports IPv6 addressing as a URL.
- 2 Select one of the IPv6 addresses (**Link-local Address**, **Stateless Address**, **Stateful Address**, **Manual Address**) from **Network Configuration Report** (see "Printing a network configuration report" on page 13).
- 3 Enter the IPv6 addresses (e.g.,: http://[FE80::215:99FF:FE66:7701]).



Address must be enclosed in '[']' brackets.



Make sure your machine supports a wireless network. Wireless network may not be available depending on the model.



Getting started

Understanding your network type

Typically, you can only have one connection between your computer and the machine at a time.

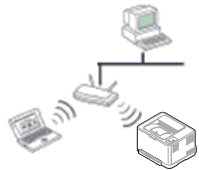

Infrastructure mode

This is an environment generally used for homes and SOHOs (Small Office/ Home Office). This mode uses an access point to communicate with the wireless machine.



Ad hoc mode

This mode does not use an access point. The wireless computer and wireless machine communicates directly.

Wireless network name and network key

Wireless networks require higher security, so when an access point is first set up, a network name (SSID), the type of security used, and a Network Key are created for the network. Locate this information before proceeding with the machine installation.





Choosing the installation type

You can install a wireless network from the machine's control panel or the computer.

From the control panel

For most users, we recommend using the  (WPS) button to configure the wireless network settings.

-  (WPS): If your machine and an access point (or wireless router) support Wi-Fi Protected Setup™ (WPS), you can easily configure the wireless network settings by pressing the  (WPS) button on the control panel (see "Using the WPS button" on page 28).
- **Control panel:** You can configure wireless parameters with the control panel (see "Using the menu button" on page 32).

From the computer

From the computer, we recommend using a USB cable with the program provided in the supplied software CD.

See "Setup using Windows" on page 34.

- **With a USB cable:** You can simply set up a wireless network using the program on the supplied software CD. Only Windows and Macintosh operating systems are supported (see "Setup using Windows" on page 34 or "Setup using Macintosh" on page 42).



You can also install a wireless network in Printer Settings Utility with a USB cable after installing the driver (Windows and Macintosh operating systems are supported).

- **With a network cable:** You can set up a wireless network using the SyncThru™ Web Service program (see "Using a network cable" on page 48).



Using the WPS button

If your machine and an access point (or wireless router) support Wi-Fi Protected Setup™ (WPS), you can easily configure the wireless network settings by pressing the  (WPS) button on the control panel without a computer.





If you want to use the wireless network using the infrastructure mode, make sure that the network cable is disconnected from the machine. Using the **WPS (PBC)** button or entering the PIN from the computer to connect to the access point (or wireless router) varies depending on the access point (or wireless router) you are using. Refer to the user's guide of the access point (or wireless router) you are using.

Items to prepare

- Check if the access point (or wireless router) supports Wi-Fi Protected Setup™ (WPS).
- Check if your machine supports Wi-Fi Protected Setup™ (WPS).
- Networked computer (PIN mode only)

Choosing your type

There are two methods available to connect your machine to a wireless network using the  (WPS) button on the control panel.

The **Push Button Configuration (PBC)** method allows you to connect your machine to a wireless network by pressing both the  (WPS) button on the control panel of your machine and the WPS (PBC) button on a Wi-Fi Protected Setup™ (WPS)-enabled access point (or wireless router) respectively.

The **Personal Identification Number (PIN)** method helps you connect your machine to a wireless network by entering the supplied PIN information on a Wi-Fi Protected Setup™ (WPS)-enabled access point (or wireless router).

Factory default in your machine is **PBC** mode, which is recommended for a typical wireless network environment.



To change the WPS mode, press  (**Menu**) > **Network** > **Wireless** > **OK** > **WPS Setting**.

Machines with an display screen

► Connecting in PBC mode

- 1 Press and hold the  (WPS) button on the control panel for more than 2 seconds.

The machine starts waiting for up to two minutes until you press the WPS (PBC) button on the access point (or wireless router).

- 2 Press the **WPS (PBC)** button on the access point (or wireless router).

The messages are displayed on the display screen in the order below:

- a Connecting:** The machine is connecting to the access point (or wireless router).
- b Connected:** When the machine is successfully connected to the wireless network, the WPS LED light stays on.
- c AP SSID:** After completing the wireless network connection process, the AP's SSID information appears on the display.

► Connecting in PIN mode

1 Press and hold the  (WPS) button on the control panel for more than 2 seconds.

2 The eight-digit PIN appears on the display.

You need to enter the eight-digit PIN within two minutes to the computer which is connected to the access point (or wireless router).

The messages are displayed on the display screen in the order below:

- a Connecting:** The machine is connecting to the wireless network.
- b Connected:** When the machine is successfully connected to the wireless network, the WPS LED light stays on.
- c AP SSID:** After completing the wireless network connection process, the AP's SSID information is displayed on the LCD display.

Machines without an display screen

► Connecting in PBC mode



1 Press and hold the  (WPS) button on the control panel for about 2 - 4 seconds until the status LED blinks quickly.

The machine starts connecting to the wireless network. The LED blinks slowly for up to two minutes until you press the PBC button on the access point (or wireless router).

2 Press the **WPS (PBC)** button on the access point (or wireless router).

- a** The light blinks fast on the WPS LED. The machine is connecting to the access point (or wireless router).
- b** When the machine is successfully connected to the wireless network, the WPS LED light stays on.

► Connecting in PIN mode

- 1** The network configuration report, including PIN, must be printed.
In ready mode, press and hold the  (**Cancel** or **Stop/Clear**) button on the control panel for about 5 seconds. You can find your machine's PIN number.
- 2** Press and hold the  (WPS) button on the control panel for more than 4 seconds until the status LED stays on.
The machine starts connecting to the access point (or wireless router).
- 3** You need to enter the eight-digit PIN within two minutes on the computer that is connected to the access point (or wireless router).
The LED blinks slowly for up to two minutes until you enter the eight-digit PIN.
The WPS LED blinks in the order below:
 - a** The light blinks fast on the WPS LED. The machine is connecting to the access point (or wireless router).
 - b** When the machine is successfully connected to the wireless network, the WPS LED light stays on.

Re-connecting to a network

When the wireless function is off, the machine automatically tries to re-connect to the access point (or wireless router) with the previously used wireless connection settings and address.



In the following cases, the machine automatically re-connects to the wireless network:

- The machine is turned off and on again.
- The access point (or wireless router) is turned off and on again.

Canceling the connection process

To cancel the wireless network connection when the machine is connecting to the wireless network, press and release the  (**Cancel** or **Stop/Clear**) button on the control panel. **You need to wait 2 minutes to re-connect to the wireless network.**

Disconnecting from a network

To disconnect the wireless network connection, press the  (WPS) button on the control panel for more than two seconds.

- **When the Wi-Fi network is in idle mode:** The machine is immediately disconnected from the wireless network, and the WPS LED is off.
- **When the Wi-Fi network is being used:** While the machine waits until the current job is finished, the light blinks fast on the WPS LED. Then, the wireless network connection is automatically disconnected. The WPS LED is off.



Using the menu button

Before starting, you will need to know the network name (SSID) of your wireless network and the network key if it is encrypted. This information was set when the access point (or wireless router) was installed. If you do not know about your wireless environment, please ask the person who set up your network.



After completing the wireless network connection, you need to install a machine driver to print from an application (see "Installing driver over the network" on page 17).

- 1 Press the  (**Menu**) button on the control panel.
- 2 Press **Network** > **OK** > **Wireless** > **OK** > **WLAN Settings** > **OK**.
- 3 Press the **OK** to select the setup method you want.
 - **Wizard:** The wireless network interface card in your machine searches for wireless networks in the area and shows the results.
 - **Custom:** You can configure the wireless settings according to your needs.

Wizard mode

- 1 The wireless network interface card on your machine searches for wireless networks in the area and shows the results.
- 2 Press **Search List** > **OK** > select a the network > **OK**.
You can select a network using SSID.
- 3 Press **WLAN Security** > **OK** > **None** > **OK**.
If you see another message, go to the next step.

- 4** According to the network you selected, the WLAN security encryption type will be **WEP** or **WPA**.
- In case of **WEP**, press the **Open System** or **SharedKey**.
 - **Open System: Authentication** is not used, and **Encryption** may or may not be used, depending on the need for data security. Enter the **WEP Key** after selecting **Open System**.
 - **SharedKey: Authentication** is used. A device that has a proper WEP Key can access the network. Enter the **WEP Key** after selecting **SharedKey**.
 - In case of **WPA**, enter the WPA Key. The key length should be between 8 and 63 characters long.

- 5** Press **OK**.

Custom mode

- 1** Enter the SSID when **Edit SSID** appears on the top line of the display, the name that identifies a wireless network. SSID is case-sensitive so you need to enter it carefully. Press **OK**.
- 2** Select the type of wireless connections.

- 3** Press **OK** to select the method of **Operation Mode**.
- **Ad-hoc:** Allows wireless devices to communicate directly with each other in a peer-to-peer environment. Go to step 4.
 - **Infrastructure:** Allows wireless devices to communicate with each other through an access point. Go to step 5.
- 4** Press **OK** to select the method of **Channel**.
If you select **Auto**, the wireless network interface card on your machine will automatically adjust the channels.
- 5** Press **OK** to select the method of **WLAN Security**.
- **None:** This is used when the validation of a wireless device's identity and data encryption are not required for your network. Open system is used for IEEE 802.11 authentication.
 - **Static WEP:** This uses the WEP (Wired Equivalent Privacy) algorithm suggested by IEEE 802.11 standard for security. Static WEP security mode requires a proper WEP key for data encryption, decryption, and IEEE 802.11 authentication. Press **OK** to select the setup method in **Authentication**
 - **Open System: Authentication** is not used, and encryption may or may not be used, depending on the need for data security. Enter the **WEP Key**.

- **SharedKey: Authentication** is used. Enter the **WEP Key** after selecting **SharedKey**.
- **WPA-PSK or WPA2-PSK:** You can select **WPA-PSK** or **WPA2-PSK** to authenticate the print server based on WPA Pre-Shared Key. This uses a shared secret key (generally called Pre-Shared Key passphrase), which is manually configured on the access point and each of its clients.
 - a Press **OK** when **WPA-PSK** or **WPA2-PSK** appears of on the display.
 - b Press **OK** to select **TKIP** or **AES** in **Encryption**. If you select **WPA2-PSK**, press **OK** to select **AES** or **TKIP + AES** in **Encryption**.
 - c Enter the **WPA Key**.

6 Press **OK**.



Disconnect the network cable (standard or crossover). Your machine should then start communicating wirelessly with the network. In case of Ad-hoc mode, you can use a wireless LAN and wired LAN simultaneously.



Setup using Windows



Shortcut to **Wireless Setting** program without CD: If you have installed the printer driver once, you can access the **Wireless Setting** program without CD. From the Start menu, select **Programs** or **All Programs** > **Samsung Printers** > **your printer driver name** > **Wireless Setting Program**.

Access point via USB cable

► Items to prepare

- Access point
- Network-connected computer
- Software CD that was provided with your machine
- The machine installed with a wireless network interface
- USB cable

► Creating the infrastructure network

- 1** Check whether the USB cable is connected to the machine.
- 2** Turn on your computer, access point, and machine.

3 Insert the supplied software CD into your CD-ROM drive.

4 Select the **Wireless Setting and Installation** option.

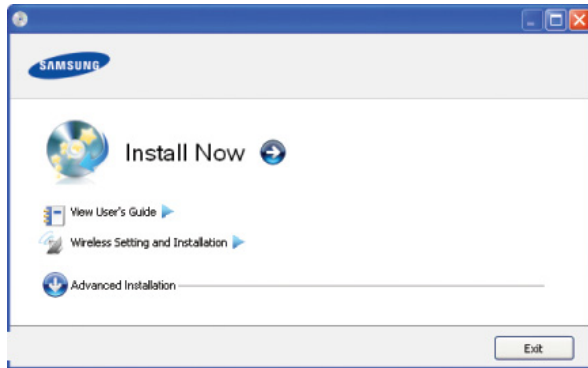

- **Install Now:** If you have already set up the wireless network, click this button to install the machine's driver to use the wireless network machine. If you have not set up the wireless network, click the **Wireless Setting and Installation** button to set up the wireless network before you click this button.
- **Wireless Setting and Installation:** Configure the wireless network settings of your machine with a USB cable then install the machine driver. This is only for users who have not set up the wireless connection before.

5 Read the **License Agreement**, and select **I accept the terms of the License Agreement**. Then, click **Next**.

6 The software searches the wireless network.



If the search has failed, you may check if the USB cable is properly connected between the computer and machine, and follow the instructions on the window.

7 After searching, the window shows the wireless network devices. Select the name (SSID) of the access point you are using and click **Next**.



If you cannot find the network name you want to choose, or if you want to set the wireless configuration manually, click **Advanced Setting**.

- **Enter the wireless Network Name:** Enter the SSID of access point you want (SSID is case-sensitive).
- **Operation Mode:** Select **Infrastructure**.
- **Authentication:** Select an authentication type.
 - Open System:** Authentication is not used, and encryption may or may not be used, depending on the need for data security.
 - Shared Key:** Authentication is used. A device that has a proper WEP key can access the network.
 - WPA Personal or WPA2 Personal:** Select this option to authenticate the print server based on WPA Pre-Shared Key. This uses a shared secret key (generally called Pre-Shared Key pass phrase) which is manually configured on the access point and each of its clients.

- **Encryption:** Select the encryption (None, WEP64, WEP128, TKIP, AES, TKIP AES).
- **Network Key:** Enter the encryption network key value.
- **Confirm Network Key:** Confirm the encryption network key value.
- **WEP Key Index:** If you are using WEP Encryption, select the appropriate **WEP Key Index**.



The wireless network security window appears when the access point has security settings.

The wireless network security window appears. The window may differ according to its security mode: WEP, or WPA.

- **WEP**

Select **Open System** or **Shared Key** for the authentication and enter the WEP security key. Click **Next**.

WEP (Wired Equivalent Privacy) is a security protocol preventing unauthorized access to your wireless network. WEP encrypts the data portion of each packet exchanged on a wireless network using a 64-bit or 128-bit WEP encryption key.

- **WPA**

Enter the WPA shared key and click **Next**.

WPA authorizes and identifies users based on a secret key that changes automatically at regular intervals. WPA also uses TKIP (Temporal Key Integrity Protocol) and AES (Advanced Encryption Standard) for data encryption.

8 The window shows the wireless network settings and checks if the settings are correct. Click **Next**.

- For the DHCP method

If the IP address assignment method is DHCP, check if DHCP is shown in the window. If it shows Static, click **Change TCP/IP** to change the assignment method to DHCP.

- For the Static method

If the IP address assignment method is Static, check if Static is shown in the window. If it shows DHCP, click **Change TCP/IP** to enter the IP address and other network configuration values for the machine. Before entering the IP address for the machine, you must know the computer's network configuration information. If the computer is set to DHCP, you must contact the network administrator to get the static IP address.

For example:

If the computer's network information is as shown below:

- IP address: 169.254.133.42
- Subnet Mask: 255.255.0.0

Then, the machine's network information should be as follows:

- IP address: 169.254.133.**43**

- Subnet Mask: 255.255.0.0 (Use the computer's subnet mask.)
- Gateway: 169.254.133.1

9 When the wireless network setting is completed, disconnect the USB cable between the computer and machine. Click **Next**.

10 The **Wireless Network Setting Complete** window appears. Select **Yes** if you accept the current settings and continue the setup procedure.

Select **No** if you want to return to the beginning screen.

Then, click **Next**.

11 Click **Next** when the **Confirm Printer Connection** window appears.

12 Select the components to be installed. Click **Next**.

13 After selecting the components, you can also change the machine name, set the machine to be shared on the network, set the machine as the default machine, and change the port name of each machine. Click **Next**.

14 After the installation is finished, a window asking you to print a test page appears. If you want to print a test page, click **Print a test page**.

Otherwise, just click **Next** and go to step 16.

15 If the test page prints out correctly, click **Yes**.
If not, click **No** to reprint it.

16 To register as a user of the machine in order to receive information from Samsung, click **On-line Registration**.

17 Click **Finish**.

Ad hoc via USB cable

If you do not have an access point (AP), you may still connect the machine wirelessly to your computer by setting up an ad-hoc wireless network by following the simple steps below.

► Items to prepare

- Network-connected computer
- Software CD that was provided with your machine
- The machine installed with a wireless network interface
- USB cable

► Creating the ad hoc network in Windows

- 1** Check whether the USB cable is connected to the machine.
- 2** Turn on your computer and the wireless network machine.
- 3** Insert the supplied software CD into your CD-ROM drive.
- 4** Select the **Wireless Setting and Installation** option.

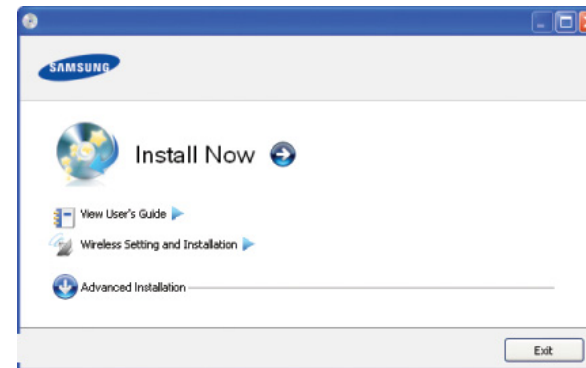

- **Install Now:** If you have set the wireless network, click this button to install the machine's driver to use the wireless network machine. If you have not set the wireless network, click **Wireless Setting and Installation** button to set the wireless network before you click this button.
- **Wireless Setting and Installation:** Configure the wireless network settings of your machine's with a USB cable then install the machine driver. This only for users who have not set up the wireless connection before.

5 Read the **License Agreement**, and select **I accept the terms of the License Agreement**. Then, click **Next**.

6 The software searches the wireless network.



If the software has failed to search the network, check if the USB cable is connected properly between the computer and machine, and follow the instruction in the window.

7 After searching the wireless networks, a list of wireless networks your machine has searched appears.

If you want to use the Samsung default ad hoc setting, select the last wireless network on the list, **Network Name(SSID)** is **portthru** and **Signal** is **Printer Self Network**.

Then, click **Next**.

If you want to use other ad hoc settings, select another wireless network from the list.



If you want to change ad hoc settings click the **Advanced Setting** button.

- **Enter the wireless Network Name:** Enter the SSID name you want (SSID is case-sensitive).
- **Operation Mode:** Select ad hoc.

- **Channel:** Select the channel. (**Auto Setting** or 2412 MHz to 2467 MHz).
- **Authentication:** Select an authentication type.
 - **Open System:** Authentication is not used, and encryption may or may not be used, depending on the need for data security.
 - **Shared Key:** Authentication is used. A device that has a proper WEP key can access the network.
- **Encryption:** Select the encryption (None, WEP64, WEP128).
- **Network Key:** Enter the encryption network key value.
- **Confirm Network Key:** Confirm the encryption network key value.
- **WEP Key Index:** If you are using WEP Encryption, select the appropriate **WEP Key Index**.

The wireless network security window appears when the ad hoc network has security setting.

The wireless network security window appears. Select **Open System** or **Shared Key** for the authentication and click **Next**.

- WEP (Wired Equivalent Privacy) is a security protocol preventing unauthorized access to your wireless network. WEP encrypts the data portion of each packet exchanged on a wireless network using a 64-bit or 128-bit WEP encryption key.

- 8 The window showing the wireless network setting appears. Check the settings and click **Next**.



Before entering the IP address for the machine, you must know the computer's network configuration information. If the computer's network configuration is set to DHCP, the wireless network setting should also be DHCP. Likewise, if the computer's network configuration is set to Static, the wireless network setting should also be Static.

If your computer is set to DHCP and you want to use the Static wireless network setting, you must contact the network administrator to get the static IP address.

- **For the DHCP method**

If the IP address assignment method is DHCP, check if DHCP is shown in the **Wireless Network Setting Confirm** window. If it shows Static, click **Change TCP/IP** to change the assignment method to **Receive IP address automatically (DHCP)**.

- **For the Static method**

If the IP address assignment method is Static, check if Static is shown in the **Wireless Network Setting Confirm** window. If it shows DHCP, click **Change TCP/IP** to enter the IP address and other network configuration values for the machine.

For example:

If the computer's network information is as shown follows:

- IP address: 169.254.133.42
- Subnet Mask: 255.255.0.0

Then, the machine's network information should be as below:

- IP address: 169.254.133.43
- Subnet Mask: 255.255.0.0 (Use the computer's subnet mask.)
- Gateway: 169.254.133.1

9 When the wireless network settings are completed, disconnect the USB cable between the computer and machine. Click **Next**.



If the **Change PC Network Setting** window appears, follow the steps in the window.

Click **Next** if you are finished with the computer's wireless network settings.

If you set the computer's wireless network on DHCP, it will take several minutes to receive the IP address.

10 The **Wireless Network Setting Complete** window appears. Select **Yes** if you accept the current settings and continue the setup procedure.

Select **No** if you want to return to the beginning screen.

Then, click **Next**.

11 Click **Next** when the **Confirm Printer Connection** window appears.

- 12 Select the components to be installed. Click **Next**.
- 13 After selecting the components, you can also change the machine name, set the machine to be shared on the network, set the machine as the default machine, and change the port name of each machine. Click **Next**.
- 14 After the installation is finished, a window asking you to print a test page appears. If you want to print a test page, click **Print a test page**.
Otherwise, just click **Next** and go to step 15.
- 15 If the test page prints out correctly, click **Yes**.
If not, click **No** to reprint it.
- 16 To register as a user of the machine in order to receive information from Samsung, click **On-line Registration**.
- 17 Click **Finish**.



Setup using Macintosh

Items to prepare

- Access point
- Network-connected computer
- Software CD that was provided with your machine
- The machine installed with a wireless network interface
- USB cable

Access point via USB cable

- 1 Check whether the USB cable is connected to the machine.
- 2 Turn on your computer, access point, and machine.
- 3 Insert the supplied software CD into your CD-ROM drive.
- 4 Double-click the CD-ROM icon that appears on your Macintosh desktop.
- 5 Double-click the **MAC_Installer** folder.
- 6 Double-click the **Installer OS X** icon.

- 7 Enter the password and click **OK**.
- 8 Click **Continue**.
- 9 Read the license agreement and click **Continue**.
- 10 Click **Agree** to agree to the license agreement.
- 11 Click **Continue**.
- 12 Select **Easy Install** and click **Install**. **Easy Install** is recommended for most users. All components necessary for machine operations will be installed.

If you select **Custom Install**, you can choose which individual operations will be installed.
- 13 Select the **Wireless Setting and Installation** option.
- 14 The software searches the wireless network.



If the search has failed, you may check if the USB cable is connected between the computer and machine properly, and follow the instructions in the window.

- 15 After searching, the window shows the wireless network devices. Select the name (SSID) of the access point you are using and click **Next**.



When you set the wireless configuration manually, click **Advanced Setting**.

- **Enter the wireless Network Name:** Enter the SSID of the access point you want with (SSID is case-sensitive).
- **Operation Mode:** Select **Infrastructure**.
- **Authentication:** Select an authentication type.
Open System: Authentication is not used, and encryption may or may not be used, depending on the need for data security.
Shared Key: Authentication is used. A device that has a proper WEP key can access the network.
WPA Personal or WPA2 Personal: Select this option to authenticate the print server based on WPA Pre-Shared Key. This uses a shared secret key (generally called Pre-Shared Key pass phrase) that is manually configured on the access point and each of its clients.
- **Encryption:** Select the encryption. (None, WEP64, WEP128, TKIP, AES, TKIP, AES)
- **Network Key:** Enter the encryption network key value.
- **Confirm Network Key:** Confirm the encryption network key value.
- **WEP Key Index:** If you are using WEP Encryption, select the appropriate **WEP Key Index**.

The wireless network security window appears when the access point has security setting.

The wireless network security window appears. The window may differ according to its security mode: WEP or WPA.

- **WEP**

Select **Open System** or **Shared Key** for the authentication and enter the WEP security key. Click **Next**.

WEP (Wired Equivalent Privacy) is a security protocol preventing unauthorized access to your wireless network. WEP encrypts the data portion of each packet exchanged on a wireless network using a 64-bit or 128-bit WEP encryption key.

- **WPA**

Enter the WPA shared key and click **Next**.

WPA authorizes and identifies users based on a secret key that changes automatically at regular intervals. WPA also uses TKIP (Temporal Key Integrity Protocol) and AES (Advanced Encryption Standard) for data encryption.

16 The window shows the wireless network settings and check if settings are right. Click **Next**.

- **For the DHCP method**

If the IP address assignment method is DHCP, check if DHCP is shown in the window. If it shows Static, click **Change TCP/IP** to change the assignment method to DHCP.

- **For the Static method**

If the IP address assignment method is Static, check if Static is shown in the window. If it shows DHCP, click **Change TCP/IP** to enter the IP address and other network configuration values for the machine. Before entering the IP address for the machine, you must know the computer's network configuration information. If the computer is set to DHCP, you must contact the network administrator to get the static IP address.

For example:

If the computer's network information is as shown follows:

- IP address: 169.254.133.42
- Subnet Mask: 255.255.0.0

Then, the machine's network information should be as follows:

- IP address: 169.254.133.**43**

- Subnet Mask: 255.255.0.0 (Use the computer's subnet mask.)
- Gateway: 169.254.133.1

17 The wireless network connects according to the network configuration.

18 When the wireless network settings are completed, disconnect the USB cable between the computer and machine.

19 Follow the instructions on the screen to complete the installation. After the installation is finished, click **Quit** or **Restart**.

Ad hoc via USB cable

If you do not have an access point (AP), you may still connect the machine wirelessly to your computer by setting up an ad hoc wireless network by following these simple directions.

► Items to prepare

- Network-connected computer
- Software CD that provided with your machine
- The machine installed with a wireless network interface

- USB cable

► Creating the ad hoc network in Macintosh

1 Check whether the USB cable is connected to the machine.

2 Turn on your computer and machine.

3 Insert the supplied software CD into your CD-ROM drive.

4 Double-click the CD-ROM icon that appears on your Macintosh desktop.

5 Double-click the **MAC_Installer** folder.

6 Double-click the **Installer OS X** icon.

7 Enter the password and click **OK**.

8 Click **Continue**.

9 Read the license agreement and click **Continue**.

10 Click **Agree** to agree to the license agreement.

11 Select **Easy Install** and click **Install**. **Easy Install** is recommended for most users. All components necessary for machine operations will be installed.

If you select **Custom Install**, you can choose individual operations will be installed.

12 Click **Wireless Setting and Installation**.

13 The software searches the wireless network devices.



If the search has failed, check if the USB cable is connected between the computer and machine properly, and follow the instructions in the window.

14 After searching the wireless networks, a list of wireless networks your machine has searched appears.

If you want to use the Samsung default ad hoc setting, select the last wireless network on the list, which **Network Name(SSID)** is **portthru** and **Signal** is **Printer Self Network**.

Then, click **Next**.

If you want to use other ad hoc settings, select another wireless network from the list.



If you want to change ad hoc settings click the **Advanced Setting** button.

- **Enter the wireless Network Name:** Enter the SSID name you want (SSID is case-sensitive).
- **Operation Mode:** Select ad hoc.
- **Channel:** Select the channel (**Auto Setting** or 2412 MHz to 2467 MHz).
- **Authentication:** Select an authentication type.
 - Open System:** Authentication is not used, and encryption may or may not be used, depending on the need for data security.
 - Shared Key:** Authentication is used. A device that has a proper WEP key can access the network.
- **Encryption:** Select the encryption (None, WEP64, WEP128).
- **Network Key:** Enter the encryption network key value.
- **Confirm Network Key:** Confirm the encryption network key value.
- **WEP Key Index:** If you are using WEP Encryption, select the appropriate **WEP Key Index**.



The wireless network security window appears when the ad hoc network has security setting.

The wireless network security window appears. Select **Open System** or **Shared Key** for the authentication and click **Next**.

- WEP (Wired Equivalent Privacy) is a security protocol preventing unauthorized access to your wireless network. WEP encrypts the data portion of each packet exchanged on a wireless network using a 64-bit or 128-bit WEP encryption key.

15 The window showing the wireless network settings appears. Check the settings and click **Next**.



Before entering the IP address for the machine, you must know the computer's network configuration information. If the computer's network configuration is set to DHCP, the wireless network setting should also be DHCP. Likewise, if the computer's network configuration is set to Static, the wireless network setting should also be Static.

If your computer is set to DHCP and you want to use Static wireless network setting, you must contact the network administrator to get the static IP address.

- **For the DHCP method**

If the IP address assignment method is DHCP, check if DHCP is shown in the **Wireless Network Setting Confirm** window. If it shows Static, click **Change TCP/IP** to change the assignment method to **Receive IP address automatically (DHCP)**.

- **For the Static method**

If the IP address assignment method is Static, check if Static is shown in the **Wireless Network Setting Confirm** window. If it shows DHCP, click **Change TCP/IP** to enter the IP address and other network configuration values for the machine.

For example:

If the computer's network information is as shown follows:

- IP address: 169.254.133.42
- Subnet Mask: 255.255.0.0

Then, the machine's network information should be as below:

- IP address: 169.254.133.43
- Subnet Mask: 255.255.0.0 (Use the computer's subnet mask.)
- Gateway: 169.254.133.1

16 The wireless network connects according to the network configuration.

17 When the wireless network setting is completed, disconnect the USB cable between the computer and machine.

18 Follow the instructions on the screen to complete the installation. After the installation is finished, click **Quit** or **Restart**.



Using a network cable

Your machine is a network compatible machine. To enable your machine to work with your network, you will need to perform some configuration procedures.



- After completing the wireless network connection, you need to install a machine driver to print from an application (See "Installing driver over the network" on page 17).
- See your network administrator, or the person that set up your wireless network, for information about your network configuration.

Items to prepare

- Access point
- Network-connected computer
- Software CD that was provided with your machine
- The machine installed with a wireless network interface
- Network cable

Printing a network configuration report

You can identify the network settings of your machine by printing a network configuration report.

See "Printing a network configuration report" on page 13.

IP setting using SetIP Program (Windows)

This program is used to manually set the network IP address of your machine using its MAC address to communicate with the machine. The MAC address is the hardware serial number of the network interface and can be found in the **Network Configuration Report**.

See "Setting IP address" on page 13.

Configuring the machine's wireless network

Before starting you will need to know the network name (SSID) of your wireless network and the network key if it is encrypted. This information was set when the access point (or wireless router) was installed. If you do not know about your wireless environment, please ask the person who set up your network.

To configure wireless parameters, you can use **SyncThru™ Web Service**.

Using SyncThru™ Web Service

Before starting wireless parameter configuration, check the cable connection status.

1 Check whether or not the network cable is connected to the machine. If not, connect the machine with a standard network cable.

2 Start a web browser such as Internet Explorer, Safari or Firefox and enter your machine's new IP address in the browser window.

For example,



3 Click **Login** on the upper right of the SyncThru™ Web Service website.

4 Type in the **ID** and **Password** then click **Login**.

- **ID: admin**
- **Password: sec00000**

5 When the **SyncThru™ Web Service** window opens, click **Network Settings**.

6 Click **Wireless > Wizard**.



Wizard will help you setup the wireless network configuration. However, if you want to set the wireless network directly, select **Custom**.

7 Select the one **Network Name(SSID)** in the list.

- **SSID:** SSID (Service Set Identifier) is a name that identifies a wireless network, access points, and wireless devices attempting to connect to a specific wireless network must use the same SSID. The SSID is case-sensitive.
- **Operation Mode:** **Operation Mode** refers to the type of wireless connections (See "Wireless network name and network key" on page 27).
 - **Ad-hoc:** Allows wireless devices to communicate directly with each other in a peer-to-peer environment.
 - **Infrastructure:** Allows wireless devices to communicate with each other through an access point.



If your network's **Operation Mode** is **Infrastructure**, select the SSID of the access point. If the **Operation Mode** is **Ad-hoc**, select the machine's SSID. Note that "portthru" is the default SSID of your machine.

8 Click **Next**.
If the wireless security setting window appears, enter the registered password (network key) and click **Next**.

9 The confirmation window appears, please check your wireless setup. If the setup is right, click **Apply**.



Disconnect the network cable (standard or network). Your machine should then start communicating wirelessly with the network. In case of Ad-hoc mode, you can use a wireless LAN and wired LAN simultaneously.



Turning the Wi-Fi network on/off

1 Check whether the network cable is connected to the machine. If not, connect the machine with a standard network cable.

2 Start a web browser such as Internet Explorer, Safari or Firefox and enter your machine's new IP address in the browser window.

For example,



3 Click **Login** on the upper right of the SyncThru™ Web Service website.

4 Type in the **ID** and **Password** then click **Login**.

- **ID: admin**
- **Password: sec00000**

5 When the **SyncThru™ Web Service** window opens, click **Network Settings**.

6 Click **Wireless > Custom**.

You can also turn the Wi-Fi network on/off.



Troubleshooting

Problems during setup or driver installation

► Printers Not Found

- Your machine may not be turned on. Turn on your computer and the machine.
- USB cable is not connected between your computer and machine. Connect machine to your computer using the USB cable.

- The machine does not support a wireless network. Check the machine's user's guide included on the software CD supplied with your machine and prepare a wireless network machine.

▶ **Connecting Failure - Not Found SSID**

- The machine is unable to search the network name (SSID) you have selected or entered. Check the network name (SSID) on your access point and try connecting again.
- Your access point is not turned on. Turn on your access point.

▶ **Connecting Failure - Invalid Security**

- You configured security incorrectly. Check the configured security on your access point and machine.

▶ **Connecting Failure - General Connection Error**

- Your computer is not receiving a signal from your machine. Check the USB cable and your machine's power.

▶ **Connecting Failure - Connected Wired Network**

- Your machine is connected with a wired network cable. Remove the wired network cable from your machine.

▶ **PC Connection Error**

- The configured network address is unable to connect between your computer and machine.

- For a DHCP network environment

The receives the IP address automatically (DHCP) when computer is configured to DHCP.

- For a Static network environment

The machine uses the static address when the computer is configured to static address.

For example:

If the computer's network information is as shown below:

- IP address: 169.254.133.42

- Subnet Mask: 255.255.0.0

Then, the machine's network information should be as below:

- IP address: 169.254.133.43
- Subnet Mask: 255.255.0.0 (Use the computer's subnet mask.)
- Gateway: 169.254.133.1

Other problems

If problems occur while using the machine on a network, check the following:



For information on the access point (or wireless router), refer to its own user's guide.

- Your computer, access point (or wireless router), or machine may not be turned on.
- Check the wireless reception around the machine. If the router is far from the machine or there is an obstacle, you might have difficulty receiving the signal.
- Cycle the power for the access point (or wireless router), machine, and computer. Sometimes cycling the power can recover network communication.

- Check whether firewall software (V3 or Norton) is blocking the communication.

If the computer and the machine are connected on the same network and it cannot be found when searching, firewall software might be blocking the communication. Refer to the user's guide for the software to turn it off and try searching for the machine again.

- Check whether the machine's IP address is allocated correctly. You can check the IP address by printing the network configuration report.
- Check whether the access point (or wireless router) has a configured security (password). If it has a password, refer to the access point (or wireless router) administrator.
- Check the machine's IP address. Reinstall the machine driver and change the settings to connect to the machine on the network. Due to the characteristics of DHCP, the allocated IP address could change if the machine is not used for a long time or if the access point has been reset.
- Check the wireless environment. You might not be able to connect to the network in the infrastructure environment where you need to type in a user's information before connecting to access point (or wireless router).
- This machine only supports IEEE 802.11 b/g/n and Wi-Fi. Other wireless communication types (e.g., Bluetooth) are not supported.

- When using the ad hoc mode, in operating systems such as Windows Vista, you might need to set the wireless connection setting every time you use the wireless machine.
- You cannot use Infrastructure mode and Ad hoc mode at the same time for Samsung wireless network machines.
- The machine is within the range of the wireless network.
- The machine is located away from obstacles that could block the wireless signal.

Remove any large metal objects between the access point (or wireless router) and the machine.

Make sure the machine and wireless access point (or wireless router) are not separated by poles, walls, or support columns containing metal or concrete.

- The machine is located away from other electronic devices that may interfere with the wireless signal.

Many devices can interfere with the wireless signal, including a microwave oven and some Bluetooth devices.

3. Useful setting menus



This chapter explains how to browse the current status of your machine, and the method of setting for advanced machine setup.

- **Information** 56
- **Layout** 57
- **Paper** 58
- **Graphic** 59
- **System setup** 60
- **Emulation** 63
- **Network** 64
- **Admin setup** 65



The control panel provides access to various menus to set up the machine or use the machine's functions. These menus can be accessed by pressing  (**Menu**).

- An asterisk (*) appears next to the currently selected menu.
- Some menus may not appear on the display depending on options or models. If so, it is not applicable to your machine.
- For models that do not have the display screen on the control panel, this feature is not applicable.
- Some menu names may differ from your machine depending on its options or the models.

Item	Description
Menu Map	Prints the menu map which shows the layout and current settings of this machine.
Configuration	Prints a report on the machine's overall configuration.
Supplies Info.	Prints supplies' information page.
Demo Page	Prints the demo page to check whether your machine is printing properly or not.
PCL Font (PCL Font List)	Prints the PCL font list.
PS Font (PS Font List)	Prints the PS font list.
EPSON Font (EPSON Font List)	Prints the EPSON font list.
KSC5843 Font List	Prints the KS font list.
KSC5895 List	Prints the KS5895 font list.
KSSM Font List	Prints the KSSM font list.
Stored Job List	Prints jobs currently stored in the optional memory or on a hard disk (HDD).
Usage Counter	Prints a usage page. The usage page contains the total number of pages printed.

Item	Description
Completed Job	Prints list of completed jobs.
Accounting Report	This is used only available when Job Accounting is enabled from the SyncThru™ Web Admin Service. You can print a report of printout counts for each user.

Item	Description
Orientation	Selects the direction in which information is printed on a page.
Common Margin	<ul style="list-style-type: none"> • Simplex Margin: Sets the margin for one-sided printing. • Duplex: Sets the margin for double-sided printing. • Binding: When printing on both sides of the paper, side A's margin closest to the binding will be the same as side B's margin closest to the binding. Likewise, the sides' margins farthest from the binding will be the same.
MP Tray	<p>Sets the paper margins in multi-purpose tray.</p> <ul style="list-style-type: none"> • Simplex: Sets the margin for one-sided printing. • Duplex: Sets the margins for double-sided printing.
Tray X	<p>Sets the paper margins in trays.</p> <ul style="list-style-type: none"> • Simplex: Sets the margin for one-sided printing. • Duplex: Sets the margins for double-sided printing.

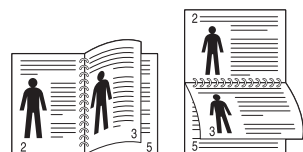
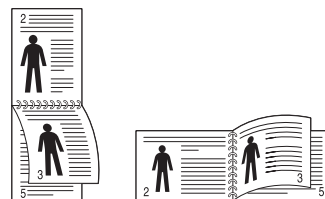
Item	Description
Emulation Mar. (Emulation Margin)	<p>Sets the paper margins for emulation print page.</p> <ul style="list-style-type: none"> • Top Margin: Sets the top margin, from 0.0 to 250 mm. • Left Margin: Sets the left margin, from 0.0 to 164 mm.
Duplex Margin	<p>To print on both sides of the paper, choose the binding edge.</p> <ul style="list-style-type: none"> • Off: Disables this option. • Long Edge: This binding is the conventional layout used in bookbinding.  <ul style="list-style-type: none"> • Short Edge: This binding is the conventional layout used in calendars. 
Landscape Stapling Position	Selects the location of the staple.

Item	Description
Copies	Selects the number of copies.
MP Tray / [Tray<x>]	<ul style="list-style-type: none">• Paper Size: Selects the default paper size.• Paper Type: Selects the paper type currently loaded in the tray.
Paper Source	Sets from which tray to use paper.
Tray Chaining (Auto Tray Switch)	<p>When you select any other value except Auto from Paper Source and the selected tray is empty, you can set the machine to automatically print from other trays.</p> <div data-bbox="353 842 1079 1015"><p>If you select Auto from Paper Source, this message does not appear.</p></div>
Tray Confirm	Activates the tray confirmation message. If you open and close a tray, a window asking you whether to set the paper size and type for the tray just opened appears.

Item	Description
Resolution	Specifies the number of dots printed per inch (dpi). The higher the setting, the sharper printed characters and graphics.
Darken Text (Clear Text)	Prints text darker than on a normal document.
Darkness	Lightens or darkens the print on the page. The Normal setting usually produces the best result. Use the Light toner density setting to save toner.

Item	Description
Date & Time	Sets the date and time.
Clock Mode	Selects the format for displaying time between 12 hr and 24 hr.
Form Menu	<ul style="list-style-type: none"> • Off: Prints in normal mode. • Single Form: Prints all page using the first form. • Double Form: Prints the front page using the first form and the back page using the second form.
Select Form	Form overlay is images stored on the printer's hard disk as a special file format that can be printed in layers on any document.
HDD Spooling	When On , stores documents on the hard disk drive (HDD) for network printing.
Language	Sets the language of the text that appears on the control panel display.
Default Paper Size	You can set the default paper size to use.

Item	Description
Power Save	<p>Sets how long the machine waits before going to power save mode.</p> <p>When the machine does not receive data for an extended period of time, power consumption is automatically lowered.</p>
Wakeup Event	<p>You can set the condition to wake up from power-save mode. Set the item on.</p> <ul style="list-style-type: none"> • Button Press: When you press any button except power button, the machine wake up from the power save mode. • Printer: When you open or close the paper tray, the machine wake up from the power save mode.
Auto Continue	<p>Determine whether or not the machine continues printing when it detects the paper does not match the paper settings.</p> <ul style="list-style-type: none"> • Off: If a paper mismatch occurs, the machine waits until you insert the correct paper. • On: If a paper mismatch occurs, an error message will display. The machine waits for about 30 second, then automatically clear the message and continue printing.
Altitude Adj.	Optimize print quality according to the machine's altitude.

Item	Description
Auto CR	Allows you to append the required carriage return to each line feed, which is useful for Unix or DOS users.
Job Timeout	When there is no input for a certain period of time, the machine cancels the current job. You can set the amount of time the machine will wait before canceling the job.
Multi-Bin	<ul style="list-style-type: none">• Mode: Selects the mult-bin mode you want to use.• Default Bin: Selects the bin to use as a default.

Item	Description
Maintenance	<ul style="list-style-type: none">• Clean Drum: Cleans the OPC drum of the cartridge by printing a sheet.• Clean Fuser: Cleans the fuser by printing a sheet.• CLR Empty Msg.: This option appears only when toner cartridge is empty.• Supplies Info.: Allows you to check how many pages are printed and how much toner is left in the cartridge.• TonerLow Alert: If toner in the cartridge has run out, a message informing the user to change the toner cartridge appears. You can set the option for this message to appear or not.• Paper Stacking: If you use a machine in a humid area, or you are using the damp print media caused by a high humidity, the print-outs on the output tray may be curled and may not be stacked properly. In this case, you can set the machine to use this function to let print-outs stacked firmly. But, using this function will make the print speed slow.
Import Setting	Imports data stored on a USB memory stick to the machine.

Item	Description
Export Setting	Exports data stored on a USB memory stick to the machine.
Toner Save	Activating this mode extends the life of your toner cartridge and reduces your cost per page beyond what one would experience in the normal mode, but it reduces print quality.
Quiet Mode	You can reduce the printing noise by turning this menu on. However, the printing speed and quality may be declined.
Eco Setup	<p>Allows you to save print resources and enables eco-friendly printing.</p> <ul style="list-style-type: none">• Default Mode: Select whether to turn the Eco mode on or off. <div data-bbox="358 1005 1075 1276"><p>Onforce: Sets the Eco mode on with password. If a user wants to turn the Eco mode on/off, the user needs to enter the password.</p></div> <ul style="list-style-type: none">• Change Template: Selects the eco template set from the SyncThru™ Web Service.
Clear Setting	Restores the machine's factory default settings.

Item	Description
Emulation Type	The machine language defines how the computer communicates with the machine.
Setup	Sets the detailed settings for the selected emulation type.

Option	Description
TCP/IP (IPv4)	<p>Selects the appropriate protocol and configure parameters to use the network environment.</p> <div style="border: 1px solid #ccc; padding: 10px; margin-top: 10px;">  <p>There are lots of parameters to be set. If you are not sure, leave as is, or consult the network administrator.</p> </div>
TCP/IP (IPv6)	Selects this option to use the network environment through IPv6 (see "IPv6 configuration" on page 24).
Ethernet Speed	Configure the network transmission speed.
802.1x	You can select the user authentication for network communication. For detailed information consult the network administrator.
Wireless	Selects this option to use the wireless network.
Clear Setting	Reverts the network settings to the default values.
Network Conf. (Network Configuration)	This list shows information on your machine's network connection and configuration.
Net. Activate	You can set whether to use Ethernet on or off.

Option	Description
Http Activate	You can set whether to use SyncThru™ Web Service or not.

Item	Description
Password Protect	Sets the password to access the Admin Setup menu. Select On to use this option and enter the password.
Change Password	Changes the machine's password for accessing the Admin Setup .
Maintenance	<ul style="list-style-type: none">• Clean Fuser: Cleans the fuser by printing a sheet. The printed sheet has toner debris on it.• CLR Empty Msg.: Prevents the TonerLow Alert message from appearing on the display.• Supplies Info.: Allows you to check how many pages are printed and how much toner is left in the cartridge.• TonerLow Alert: If toner in the cartridge has run out, a message informing the user to change the toner cartridge appears. You can set the option for this message to appear or not.• Ram Disk: Enables/disables RAM disk to manage jobs. Depending on the installed optional memory size, you can set the RAM disk size to between 32 and 64 MB. This option does not appear if you have installed hard disk drive (HDD).

4. Special features



This chapter explains special printing features.

- **Altitude adjustment** 67
- **Changing the font setting** 68
- **Changing the default print settings** 69
- **Setting your machine as a default machine** 70
- **Using advanced print features** 71
- **Using Direct Printing Utility (Windows only)** 79
- **Using memory/hard drive features** 81
- **Macintosh printing** 83
- **Linux printing** 85
- **Unix printing** 88



The procedures in this chapter are mainly based on Windows 7.

Print quality is affected by atmospheric pressure, which is determined by the height of the machine above sea level. The following information will guide you on how to set your machine for the best print quality.

Before you set the altitude value, determine the altitude where you are.

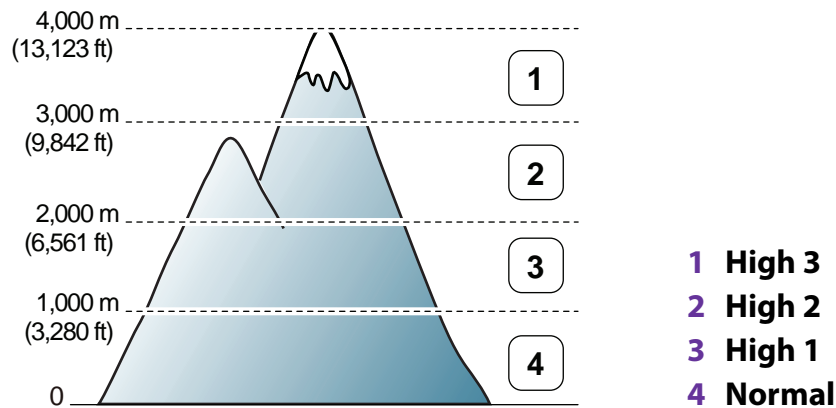

- For Windows user, see "Device Settings" on page 97.
- For Macintosh, Linux, or Unix OS user, see "Using Smart Panel (Macintosh and Linux only)" on page 99.



- If your machine is connected to the network, you can set the altitude via SyncThru™ Web Service.
- You can also set the altitude in **System Setup** option on the machine's display.

Your machine has preset the font for your region or country.

If you want to change the font or set the font for special condition, such as the DOS environment, you can change the font setting from **Device Settings** or **Emulation** section.

- For Windows user, see "Device Settings" on page 97.
- For Macintosh, Linux, or Unix OS user, see "Using Smart Panel (Macintosh and Linux only)" on page 99.



- If your machine is connected to the network, you can set the font setting via SyncThru™ Web Service.
- You can also change the font setting in **Emulation** option on the machine's display.
- The following information shows the proper font list for corresponding languages.
 - **Russian:** CP866, ISO 8859/5 Latin Cyrillic
 - **Hebrew:** Hebrew 15Q, Hebrew-8, Hebrew-7 (Israel only)
 - **Greek:** ISO 8859/7 Latin Greek, PC-8 Latin/Greek
 - **Arabic & Farsi:** HP Arabic-8, Windows Arabic, Code Page 864, Farsi, ISO 8859/6 Latin Arabic
 - **OCR:** OCR-A, OCR-B

- 1 Click the Windows **Start** menu.
- 2 For Windows Server 2000, select **Settings > Printers**.
 - For Windows XP/Server 2003, select **Printer and Faxes**.
 - For Windows Server 2008/Vista, select **Control Panel > Hardware and Sound > Printers**.
 - For Windows 7, select **Control Panel > Devices and Printers**.
 - For Windows Server 2008 R2, select **Control Panel > Hardware > Devices and Printers**.

3 Right-click on your machine.

4 For Windows XP/Server 2003/Server 2008/Vista, select **Printing Preferences**.

For Windows 7 or Windows Server 2008 R2, from context menus, select **Printing preferences**.



If you want to change the settings for each print job, change it in **Printing Preferences**.



If **Printing preferences** has a ?, you can select other printer drivers connected to the selected printer.

5 Change the settings on each tab.

6 Click **OK**.

- 1 Click the Windows **Start** menu.
- 2 For Windows Server 2000, select **Settings > Printers**.
 - For Windows XP/Server 2003, select **Printer and Faxes**.
 - For Windows Server 2008/Vista, select **Control Panel > Hardware and Sound > Printers**.
 - For Windows 7, select **Control Panel > Devices and Printers**.
 - For Windows Server 2008 R2, select **Control Panel > Hardware > Devices and Printers**.
- 3 Select your machine.
- 4 Right-click your machine and select **Set as Default Printer**.



For Windows 7 or Windows Server 2008 R2, if **Set as default printer** has a ?, you can select other printer drivers connected to the selected printer.



XPS printer driver: used to print XPS file format.

- The XPS printer driver can be installed only on Windows Vista OS or higher.
- You can install the XPS printer driver when you insert the software CD into your CD-ROM drive. When the installation window appears, select **Advanced Installation > Custom Installation**. You can select the XPS printer driver in the **Select Software and Utilities to Install** window.
- Install optional memory when an XPS job does not print because the printer is out of memory.



Printing to a file (PRN)

You will sometimes need to save the print data as a file.

- 1 Check the **Print to file** box in the **Print** window.

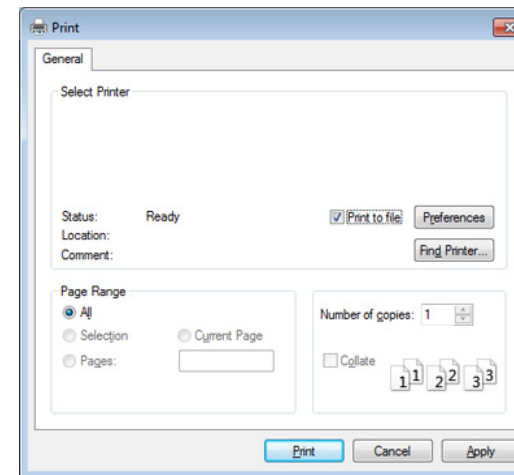

- 2 Click **Print**.

- 3 Type in the destination path and the file name, and then click **OK**.

For example, **c:\Temp\file name**.



If you type in only the file name, the file is automatically saved in **My Documents**, **Documents and Settings**, or **Users**. The saved folder may differ, depending on your operating system or the application you are using.







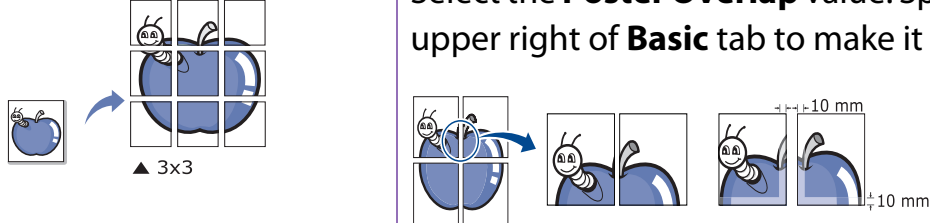

Understanding special printer features

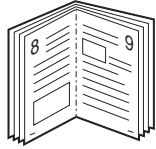
You can use advanced printing features when using your machine.

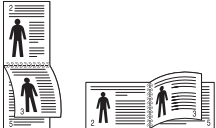
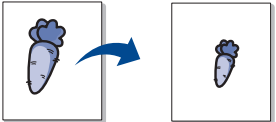

To take advantage of the printer features provided by your printer driver, click **Properties** or **Preferences** in the application's **Print** window to change the print settings. The machine name, that appears in the printer properties window may differ depending on the machine in use.

Item	Description
<p data-bbox="51 646 432 683">Multiple Pages per Side</p> 	<p data-bbox="465 646 2186 730">Selects the number of pages to print on a single sheet of paper. To print more than one page per sheet, the pages will be reduced in size and arranged in the order you specify. You can print up to 16 pages on one sheet.</p>
<p data-bbox="51 981 297 1018">Poster Printing</p> 	<p data-bbox="465 933 2186 1018">Prints a single-page document onto 4 (Poster 2x2), 9 (Poster 3x3), or 16 (Poster 4x4) sheets of paper, for the purpose of pasting the sheets together to form one poster-size document.</p> <p data-bbox="465 1038 2186 1123">Select the Poster Overlap value. Specify Poster Overlap in millimeters or inches by selecting the radio button on the upper right of Basic tab to make it easier to paste the sheets together.</p>

Item	Description
<p data-bbox="51 405 315 443">Booklet Printing</p> 	<p data-bbox="461 277 2190 363">Prints your document on both sides of a sheet of paper and arranges the pages so that the paper can be folded in half after printing to produce a booklet.</p> <p data-bbox="461 384 2033 422">If you want to make a booklet, you need to print on Letter, Legal, A4, US Folio, or Oficio sized print media.</p> <div data-bbox="461 475 2197 759"><p data-bbox="613 512 2190 596">The Booklet Printing option is not available for all paper sizes. Select the available paper Size option under the Paper tab to see what paper sizes are available.</p><p data-bbox="613 624 2141 708">If you select an unavailable paper size, this option can be automatically canceled. Select only available paper (paper without ⚠ or ✖ mark).</p></div>
<p data-bbox="51 959 405 997">Double-sided Printing</p>	<p data-bbox="461 791 2130 829">Print on both sides of a sheet of paper (duplex). Before printing, decide how you want your document oriented.</p> <div data-bbox="461 882 2197 1158"><ul data-bbox="613 919 2190 1114" style="list-style-type: none"><li data-bbox="613 919 1787 954">• You can use this feature with Letter, Legal, A4, US Folio or Oficio sized paper<li data-bbox="613 975 2190 1059">• If your machine does not have a duplex unit, you should complete the printing job manually. The machine prints every other page of the document first. After that, a message appears on your computer.<li data-bbox="613 1080 1800 1114">• Skip Blank Pages feature does not work when you select the duplex option.</div>

Item	Description
Double-sided Printing (Option)	<ul style="list-style-type: none">• Printer Default: If you select this option, this feature is determined by the settings you have selected on the control panel of the machine. This option is available only when you use the PCL/XPS printer driver.• None: Disables this feature.• Long Edge: This option is the conventional layout used in bookbinding. • Short Edge: This option is the conventional layout used in calendars. • Reverse Double-Sided Printing: Check this option to reverse the print order when duplex printing.
Paper Options 	Changes the size of a document to appear larger or smaller on the printed page by entering in a percentage by which to enlarge or decrease the document.
Watermark 	The watermark option allows you to print text over an existing document. For example, you use it when you want to have large gray letters reading “DRAFT” or “CONFIDENTIAL” printed diagonally across the first page or all pages of a document.

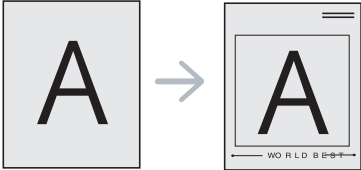
Item	Description
Watermark (Creating a watermark)	<ul style="list-style-type: none">a To change the print settings from your software application, access Printing Preferences.b Click the Advanced tab, select Edit from the Watermark drop-down list. The Edit Watermarks window appears.c Enter a text message in the Watermark Message box. You can enter up to 256 characters. The message displays in the preview window.
Watermark (Editing a watermark)	<ul style="list-style-type: none">a To change the print settings from your software application, access Printing Preferences.b Click the Advanced tab, select Edit from the Watermark drop-down list. The Edit Watermarks window appears.c Select the watermark you want to edit from the Current Watermarks list and change the watermark message and options.d Click Update to save the changes.e Click OK or Print until you exit the Print window.
Watermark (Deleting a watermark)	<ul style="list-style-type: none">a To change the print settings from your software application, access Printing Preferences.b Click the Advanced tab, select Edit from the Watermark drop-down list. The Edit Watermarks window appears.c Select the watermark you want to delete from the Current Watermarks list and click Delete.d Click OK or Print until you exit the Print window.

Item	Description
<p data-bbox="51 485 181 520">Overlay</p> 	<p data-bbox="461 277 1429 312">This option is available only when you use the PCL printer driver.</p> <p data-bbox="461 338 2190 561">An overlay is text and/or images stored in the computer hard disk drive (HDD) as a special file format that can be printed on any document. Overlays are often used to take the place of letterhead paper. Rather than using preprinted letterhead, you can create an overlay containing exactly the same information that is currently on your letterhead. To print a letter with your company's letterhead, you do not need to load preprinted letterhead paper in the machine: just print the letterhead overlay on your document.</p> <p data-bbox="461 587 1816 622">To use a page overlay, you must create a new page overlay containing your logo or image.</p> <div data-bbox="461 676 2199 938" style="background-color: #f0f0f0; padding: 10px;">  <ul data-bbox="613 715 2190 890" style="list-style-type: none"> • The overlay document size must be the same as the document you print with the overlay. Do not create an overlay with a watermark. • The resolution of the overlay document must be the same as that of the document you will print with the overlay. </div>
<p data-bbox="51 973 394 1114">Overlay (Creating a new page overlay)</p>	<ol data-bbox="461 973 2168 1353" style="list-style-type: none"> a To save the document as an overlay, access Printing Preferences. b Click the Advanced tab, and select Edit from the Text drop-down list. Edit Overlay window appears. c In the Edit Overlay window, click Create. d In the Save As window, type a name up to eight characters in the File name box. Select the destination path, if necessary (The default is C:\Formover). e Click Save. The name appears on the Overlay List. f Click OK or Print until you exit the Print window. The file is not printed. Instead, it is stored on your computer hard disk drive.

Item	Description
Overlay (Using a page overlay)	<ul style="list-style-type: none">a Click the Advanced tab.b Select the desired overlay from the Text drop-down list.c If the overlay file you want does not appear in the Text drop-down list, select Edit... from the list and click Load. Select the overlay file you want to use. If you have stored the overlay file you want to use in an external source, you can also load the file when you access the Open window. After you select the file, click Open. The file appears in the Overlay List box and is available for printing. Select the overlay from the Overlay List box.d If necessary, check Confirm Page Overlay When Printing box. If this box is checked, a message window appears each time you submit a document for printing, asking you to confirm printing an overlay on your document. If this box is not checked and an overlay has been selected, the overlay automatically prints with your document.e Click OK or Print until you exit the Print window.
Overlay (Deleting a page overlay)	<ul style="list-style-type: none">a In the Printing Preferences window, click the Advanced tab.b Select Edit in the Text drop down list.c Select the overlay you want to delete from the Overlay List box.d Click Delete.e When a confirming message window appears, click Yes.f Click OK or Print until you exit the Print window. You can delete page overlays that you no longer use.

Item	Description
Print Mode	 <ul style="list-style-type: none">• This feature is available only if you have installed the optional hard disk or set the Ram Disk. To set the Ram Disk, you must enable it from SyncThru™ Web Service Settings > Machine Settings > Ram Disk.• Some menus may not appear on the display depending on options or models. If so, it is not applicable to your machine.• You can see the print job list you set in the printer driver's Print Mode in the Job Management menu using the control panel (see "From the control panel" on page 81). <ul style="list-style-type: none">• Print Mode: The default Print Mode is Normal, which is for printing without saving the printing file in the memory.<ul style="list-style-type: none">- Normal: This mode prints without storing your document in the optional memory.- Proof: This mode is useful when you print more than one copy. You can print one copy first to check, then print the rest of the copies later.- Confidential: This mode is used for printing confidential documents. You need to enter a password to print.- Store: Select this setting to save a document in the hard disk without printing.- Store and Print: This mode is used when printing and storing document at the same time.- Spool: This option can be useful when handling large amounts of data. If you select this setting, the printer spools the document into the hard disk and then prints it from the hard disk queue, decreasing the computer's work load.- Print Schedule: Select this setting to print the document at a specified time.• User ID: This option is used when you need to find a saved file using the control panel.• Job Name: This option is used when you need to find a saved file using the control panel.



What is Direct Printing Utility?

Direct Printing Utility is a program that sends PDF files directly to your machine to print without having to opening the file.

To install this program, select **Advanced Installation > Custom Installation** and put a check mark in this program when you install the printer driver.



- For some models, a hard disk drive (HDD) should be installed or memory inserted to properly run utilities. Otherwise, they should be installed.
- You cannot print PDF files that are restricted. Deactivate the printing restriction feature and retry printing.
- You cannot print PDF files that are restricted by a password. Deactivate the password feature, and retry printing.
- Whether or not a PDF file can be printed using the Direct Printing Utility program depends on how the PDF file was created.
- The Direct Printing Utility program supports PDF version 1.7 and below. For higher versions, you must open the file to print it.



Printing

There are several ways you can print using the Direct Printing Utility.

- 1 From the **Start** menu select **Programs** or **All Programs > Samsung Printers > Direct Printing Utility > Direct Printing Utility**.

The Direct Printing Utility window appears.

- 2 Select your machine from the **Select Printer** drop-down list and click **Browse**.

- 3 Select the file you wish to print and click **Open**.

The file is added in the **Select Files** section.

- 4 Customize the machine settings for your needs.

- 5 Click **Print**. The selected PDF file is sent to the machine.



Using the right-click menu

- 1** Right-click on the PDF file to print and select **Direct Printing**.
The Direct Printing Utility window appears with the PDF file is added.
- 2** Select the machine to use.
- 3** Customize the machine settings.
- 4** Click **Print**. The selected PDF file is sent to the machine.



Some menus may not appear on the display depending on options or models. If so, it is not applicable to your machine.



From the printer driver

After installing the optional memory, you can use advanced printing features, such as proofing a job and specifying of printing a private job in the **Print** window. Select **Properties** or **Preference**, and configure the printing mode.



From the control panel

If your machine has optional memory or an optional hard drive, you can use these features from the **Job Management** menu.

- **Active Job:** All of the print jobs waiting to be printed are listed in the active job queue in the order you sent them to the printer. You can delete a job from the queue before printing, or promote a job to print sooner.
- **File Policy:** You can choose the file policy for generating file name before you proceed with the job through optional memory. If the optional memory already has the same name when you entered a new file name, you can rename or overwrite it.
- **Stored Job:** You can print or delete a stored job.
- **Held Job Timeout:** The machine can automatically delete a stored job after a certain period of time. You can set the time the machine will wait before deleting the stored job.
- **ImageOverwrite:** Image Overwrite is a security measure for customers who are concerned about unauthorized access and duplication of classified or private document.



After installing the hard drive, you can also print the predefined document templates from the **Form Menu**.



Some features may not be available depending on models or options. It means that the features are not supported.



Printing a document

When you print with a Macintosh, you need to check the printer driver settings in each application you use. Follow the steps below to print from a Macintosh:

- 1 Open the document to print.
- 2 Open the **File** menu and click **Page Setup (Document Setup)** in some applications).
- 3 Choose your paper size, orientation, scaling, other options, and make sure that your machine is selected. Click **OK**.
- 4 Open the **File** menu and click **Print**.
- 5 Choose the number of copies and indicate which pages to print.
- 6 Click **Print**.



Changing printer settings

You can use advanced printing features when using your machine.

Open an application and select **Print** from the **File** menu. The machine name, which appears in the printer properties window, may differ depending on the machine in use. Except for the name, the composition of the printer properties window is similar to the following.



Printing multiple pages on one sheet

You can print more than one page on a single sheet of paper. This feature provides a cost-effective way to print draft copies.

- 1 Open an application, and select **Print** from the **File** menu.
- 2 Select **Layout** from the drop-down list under **Orientation**. In the **Pages per Sheet** drop-down list, select the number of pages you want to print on one sheet of paper.
- 3 Select the other options to use.

4 Click **Print**.

The machine prints the selected number of pages to print on one sheet of paper.



Printing on both sides of the paper



Some features may not be available depending on models or options. It means that the features are not supported.

Before printing in the duplex mode, decide on which edge you will be binding your finished document. The binding options are, as follows:

- **Long-Edge Binding:** This option is the conventional layout used in book binding.
- **Short-Edge Binding:** This option is the type often used with calendars.

1 From your Macintosh application, select **Print** from the **File** menu.

2 Select **Layout** from the drop-down list under **Orientation**.

3 Select a binding orientation from the **Two-Sided** option.

4 Select the other options to use.

5 Click **Print** and the machine prints on both sides of the paper.



If you print more than 2 copies, the first copy and the second copy might print on the same sheet of paper. Avoid printing on both sides of paper when you are printing more than 1 copy.



Using help

Click the question mark on the bottom-left corner of the window and click on the topic you want to know about. A pop-up window appears with information about that option's feature, which is provided from the driver.

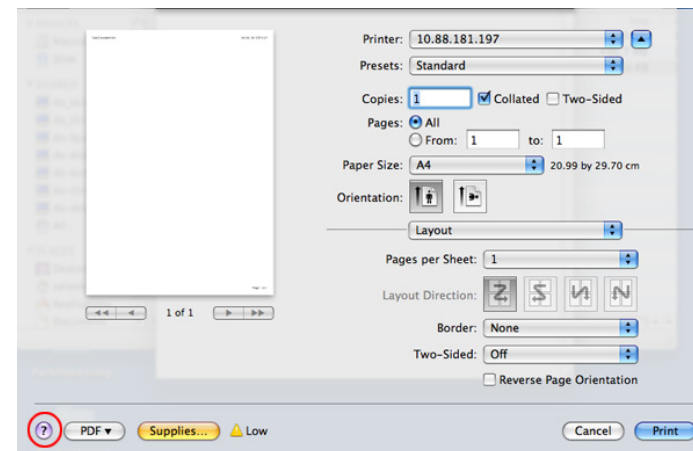



Some features may not be available depending on models or options. It means that the features are not supported.



Printing from applications

There are a lot of Linux applications that allow you to print using Common UNIX Printing System (CUPS). You can print on your machine from any such application.

- 1 Open an application, and select **Print** from the **File** menu
- 2 Select **Print** directly using `lpr`.
- 3 In the LPR GUI window, select the model name of your machine from the printer list and click **Properties**.

4

Change the print job properties using the following four tabs displayed at the top of the window.

- **General:** Changes the paper size, the paper type, and the orientation of the documents. It enables the duplex feature, adds start and end banners, and changes the number of pages per sheet.



Automatic/manual duplex printing may not be available depending on models. You can alternatively use the `lpr` printing system or other applications for odd-even printing.

- **Text:** Specifies the page margins and set the text options, such as spacing or columns.
- **Graphics:** Sets image options that are used when printing image files, such as color options, image size, or image position.
- **Advanced:** Sets the print resolution, paper source, and destination.

5

Click **Apply** to apply the changes and close the **Properties** window.

6

Click **OK** in the **LPR GUI** window to start printing.

- 7 The Printing window appears, allowing you to monitor the status of your print job.

To abort the current job, click **Cancel**.



Printing files

You can print many different types of files on your machine using the standard CUPS, directly from the command line interface. The CUPS lpr utility allows you to do that, but the driver's package replaces the standard lpr tool by a much more user-friendly LPR GUI program.

To print any document file:

- 1 Enter `lpr <file_name>` from the Linux shell command line and press Enter. The **LPR GUI** window appears.

When you type only `lpr` and press **Enter**, the **Select file(s) to print** window appears first. Just select any files you want to print and click **Open**.

- 2 In the **LPR GUI** window, select your machine from the list, and change the print job properties.

- 3 Click **OK** to start printing.



Configuring Printer Properties

Using the **Printer Properties** window provided by the **Printers configuration**, you can change the various properties for your machine as a printer.

- 1 Open the **Unified Driver Configurator**.
If necessary, switch to **Printers configuration**.
- 2 Select your machine on the available printers list and click **Properties**.
- 3 The **Printer Properties** window appears.
The following five tabs display at the top of the window:
 - **General:** Allows you to change the printer location and name. The name entered in this tab displays on the printer list in **Printers configuration**.
 - **Connection:** Allows you to view or select another port. If you change the machine port from USB to parallel or vice versa while in use, you must re-configure the machine port in this tab.
 - **Driver:** Allows you to view or select another machine driver. By clicking **Options**, you can set the default device options.

- **Jobs:** Shows the list of print jobs. Click **Cancel job** to cancel the selected job and select the **Show**

completed jobs check box to see previous jobs on the job list.

- **Classes:** Shows the class that your machine is in. Click **Add to Class** to add your machine to a specific class or click **Remove from Class** to remove the machine from the selected class.

4 Click **OK** to apply the changes and close the **Printer Properties** window.

Unix printing



Some features may not be available depending on models or options. It means that the features are not supported.



Proceeding the print job

After installing the printer, choose any of the image, text, PS or HPGL files to print.

1 Execute "**printui <file_name_to_print>**" command.

For example, if you are printing "**document1**"

```
printui document1
```

This will open the UNIX Printer Driver **Print Job Manager** in which the user can select various print options.

2 Select a printer that has been already added.

3 Select the printing options from the window such as **Page Selection**.

4 Select how many copies are needed in **Number of Copies**.



To take advantage of the printer features provided by your printer driver, press **Properties** (see "Changing printer settings" on page 83).

5 Press **OK** to start the print job.



Changing the machine settings

The UNIX printer driver **Print Job Manager** in which the user can select various print options in printer **Properties**.

The following hot keys may also be used: "H" for **Help**, "O" for **OK**, "A" for **Apply**, and "C" for **Cancel**.

General tab

- **Paper Size:** Set the paper size as A4, Letter, or other paper sizes, according to your requirements.
- **Paper Type:** Choose the type of the paper. Options available in the list box are **Printer Default**, **Plain**, and **Thick**.
- **Paper Source:** Select from which tray the paper is used. By default, it is **Auto Selection**.

- **Orientation:** Select the direction in which information is printed on a page.
- **Duplex:** Print on both sides of paper to save paper.



Automatic/manual duplex printing may not be available depending on models. You can alternatively use the lpr printing system or other applications for odd-even printing.

- **Multiple pages:** Print several pages on one side of the paper.
- **Page Border:** Choose any of the border styles (e.g., **Single-line hairline**, **Double-line hairline**)

Image tab

In this tab, you can change the brightness, resolution, or image position of your document.

Text tab

Set the character margin, line space, or the columns of the actual print output.

HPGL/2 tab

- **Use only black pen:** To print all graphics in black.
- **Fit plot to page:** Fit the entire graphic into a single page.
- **Pen Width:** Change value to increase the thickness of pen lines. By default, it is 1000.

Margins tab

- **Use Margins:** Set the margins for the document. By default, margins are not enabled. The user can change the margin settings by changing the values in the respective fields. Set by default, these values depend on the page size selected.
- **Unit:** Change the units to points, inches, or centimeters.

Printer-Specific Settings tab

Select various options in the **JCL** and **General** frames to customize various settings. These options are specific to the printer and depend on the PPD file.

5. Maintenance

This chapter introduces management tools provided to help you make full use of your machine. It also provides information for maintaining the toner cartridge.

- **Storing the toner cartridge** 90
- **Tips for moving & storing your machine** 92
- **Useful management tools** 93



Toner cartridges contain components that are sensitive to light, temperature and humidity. Samsung suggests users follow these recommendations to ensure optimal performance, highest quality, and longest life from your new Samsung toner cartridge.

Store this cartridge in the same environment in which the printer will be used. This should be in controlled temperature and humidity conditions. The toner cartridge should remain in its original and unopened package until installation – if original packaging is not available, cover the top opening of the cartridge with paper and store in a dark cabinet.

Opening the cartridge package prior to use dramatically shortens its useful shelf and operating life. Do not store on the floor. If the toner cartridge is removed from the printer, follow the instructions below to store the toner cartridge properly.

- Store the cartridge inside the protective bag from the original package.
- Store lying flat (not standing on end) with the same side facing up as if it were installed in the machine.
- Do not store consumables in any of the following conditions:
 - Temperature greater than 40°C (104°F).
 - Humidity range not less than 20% and not greater than 80%.
 - An environment with extreme changes in humidity or temperature.
 - Direct sunlight or room light.

- Dusty places.
- A car for a long period of time.
- An environment where corrosive gases are present.
- An environment with salty air.



Handling instructions

- Do not touch the surface of the photoconductive drum in the cartridge.
- Do not expose the cartridge to unnecessary vibrations or shock.
- Never manually rotate the drum, especially in the reverse direction; this can cause internal damage and toner spillage.



Toner cartridge usage

Samsung Electronics does not recommend or approve the use of non-Samsung brand toner cartridges in your printer including generic, store brand, refilled, or remanufactured toner cartridges.



Samsung's printer warranty does not cover damage to the machine caused by the use of a refilled, remanufactured, or non-Samsung brand toner cartridges.



Estimated cartridge life

Estimated cartridge life (the life of the toner cartridge yield) depends on the amount of toner that print jobs require. The actual print yield may vary depending on the print density of the pages you print on, operating environment, printing interval, media type and/or media size. For example, if you print a lot of graphics, the consumption of the toner is higher and you may need to change the cartridge more often.

- When moving the machine, do not tilt or turn it upside down. Otherwise, the inside of the machine may be contaminated by toner, which can cause damage to the machine or reduce print quality.
- When moving the machine, make sure at least two people are holding the machine securely.



Samsung AnyWeb Print

This tool helps you screen-capture, preview, scrap, and print Windows Internet Explorer pages more easily, than when you use an ordinary program. Click **Start > All programs > Samsung Printers > Samsung AnyWeb Print > Download the latest version** to link to the website where the tool is available for download.



Using SyncThru™ Web Service



- Internet Explorer 6.0 or higher is the minimum requirement for SyncThru™ Web Service.
- SyncThru™ Web Service explanation in this user's guide may differ from your machine depending on its options or models.
- Network model only.

Accessing SyncThru™ Web Service

- 1 Access a web browser, such as Internet Explorer, from Windows.

Enter the machine IP address of your printer (http://xxx.xxx.xxx.xxx) in the address field and press the Enter key or click **Go**.
- 2 Your machine's embedded website opens.

► Logging into SyncThru™ Web Service

Before configuring options in SyncThru™ Web Service, you need to log-in as an administrator. You can still use SyncThru™ Web Service without logging in but you won't have access to **Settings** tab and **Security** tab.

- 1 Click **Login** on the upper right of the SyncThru™ Web Service website.
- 2 Type in the **ID** and **Password** then click **Login**.
 - **ID: admin**
 - **Password: sec00000**

SyncThru™ Web Service overview



Some tabs may not appear depending on your model.

► Information tab

This tab gives you general information about your machine. You can check things, such as remaining amount of toner. You can also print reports, such as an error report.

- **Active Alerts:** Shows the alerts that have occurred in the machine and their severity.
- **Supplies:** Shows how many pages are printed and amount of toner left in the cartridge.
- **Usage Counters:** Shows the usage count by print types: simplex and duplex.
- **Current Settings:** Shows the machine's and network's information.
- **Print information:** Prints reports such as system related reports and font reports.

► Settings tab

This tab allows you to set configurations provided by your machine and network. You need to log-in as an administrator to view this tab.

- **Machine Settings tab:** Sets options provided by your machine.
- **Network Settings tab:** Shows options for the network environment. Sets options such as TCP/IP and network protocols.

► Security tab

This tab allows you to set system and network security information. You need to log-in as an administrator to view this tab.

- **System Security:** Sets the system administrator's information and also enables or disables machine features.
- **Network Security:** Sets settings for HTTPs, IPSec, IPv4/IPv6 filtering, and 802.1x.

► Maintenance tab

This tab allows you to maintain your machine by upgrading firmware and setting contact information for sending emails. You can also connect to Samsung website or download drivers by selecting the **Link** menu.

- **Firmware Upgrade:** Upgrade your machine's firmware.
- **Contact Information:** Shows the contact information.

- **Link:** Shows links to useful sites where you can download or check information.

E-mail notification setup

You can receive emails about your machine's status by setting this option. By setting information such as IP address, host name, e-mail address and SMTP server information, the machine status (toner cartridge shortage or machine error) will be sent to a certain person's e-mail automatically. This option may be used more frequently by a machine administrator.

- 1 Start a web browser, such as Internet Explorer, from Windows. Enter the machine IP address (http://xxx.xxx.xxx.xxx) in the address field and press the Enter key or click **Go**.
- 2 Your machine's embedded website opens.
- 3 From the **Settings** tab, select **Machine Settings > E-mail Notification**.



If you have not configured outgoing server environment, go to **Settings > Network Settings > Outgoing Mail Server(SMTP)** to configure network environment before setting e-mail notification.

- 4 Select **Enable** check box to use the **E-mail Notification**.
- 5 Click **Add** button to add e-mail notification user. Set the recipient name and e-mail address(es) with notification items you want to receive an alert for.
- 6 Click **Apply**.



If the firewall is activated, the e-mail may not be sent successfully. In that case, contact the a network administrator.

Setting the system administrator's information

This setting is necessary for using the e-mail notification option.

- 1 Start a web browser, such as Internet Explorer, from Windows. Enter the machine IP address (http://xxx.xxx.xxx.xxx) in the address field and press the Enter key or click **Go**.
- 2 Your machine's embedded website opens.
- 3 From the **Security** tab, select **System Security > System Administrator**

4 Enter the name of the administrator, phone number, location, and email address.

5 Click **Apply**.



Using Samsung Easy Printer Manager (Windows only)

Samsung Easy Printer Manager is a Windows-based application that combines Samsung machine settings into one location. Samsung Easy Printer Manager combines device settings as well as printing environments, settings/actions and launching. All of these features provide a gateway to conveniently use your Samsung machine. Samsung Easy Printer Manager provides two different user interfaces for the user to choose from: the basic user interface and the advanced user interface. Switching between the two interfaces is easy: just click a button.



Internet Explorer 6.0 or higher is the minimum requirement for Samsung Easy Printer Manager.

Understanding Samsung Easy Printer Manager



To open the program:

Select **Start > Programs** or **All Programs > Samsung Printers > Samsung Easy Printer Manager > Samsung Easy Printer Manager**.

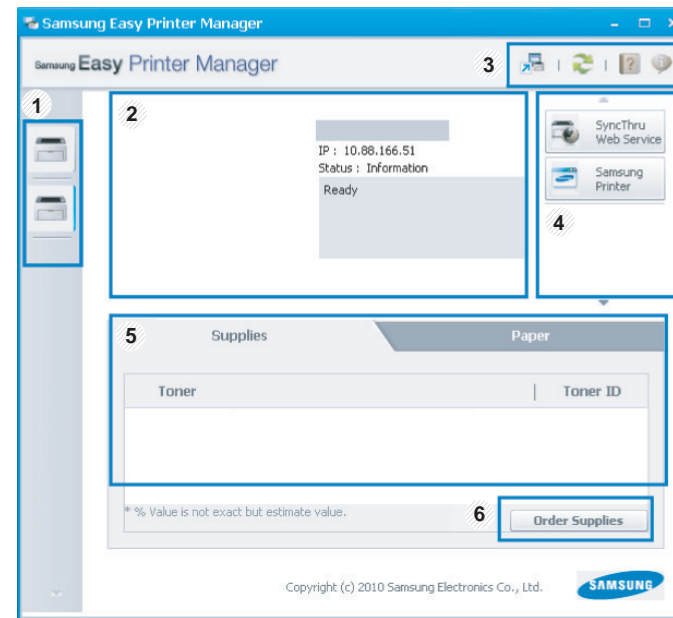
The Samsung Easy Printer Manager interface is comprised of various basic sections as described in the table that follows:



1	Printer List	The printer list displays the installed printer icons on your computer.
---	---------------------	---

2	Printer Information	<p>This area gives you general information about your machine. You can check information, such as the machine's model name, IP address (or Port name), and machine status.</p> <div data-bbox="344 437 1090 751" style="border: 1px solid #ccc; padding: 10px; margin-top: 10px;">  <p>User's Guide button: This button opens Troubleshooting Guide when an error occurs. You can directly open the necessary section in the user's guide.</p> </div>
3	Application information	<p>Includes links for changing to the advanced settings, preference, help, and about.</p> <div data-bbox="344 919 1090 1153" style="border: 1px solid #ccc; padding: 10px; margin-top: 10px;">  <p>The  button is used to change the user interface to the advanced settings user interface.</p> </div>
4	Quick links	<p>Displays Quick links to machine specific functions. This section also includes links to applications in the advanced settings.</p>
5	Contents Area	<p>Displays information about the selected machine, remaining toner level, and paper. The information will vary based on the machine selected. Some machines do not have this feature.</p>

6	Order Supplies	<p>Click on the Order button from the supply ordering window. You can order replacement toner cartridge(s) from online.</p>
---	-----------------------	--



Click the **Help** (?) button from the upper-right corner of the window and click on any option you want to know about.

Advanced settings user interface overview

The advanced user interface is intended to be used by the person responsible for managing the network and machines.

► Device Settings

You can configure various machine settings such as machine setup, paper, layout, emulation, network, and print information.

► Alert Settings

This is menu includes settings related to error alerting.

- **Printer Alert:** Provides settings related to when alerts will be received.
- **Email Alert:** Provides options relating to receiving alerts via email.
- **History Alert:** Provides a history of device and toner related alerts.

► Job Accounting

Provides querying of quota information of the specified job accounting user. This quota information can be created and applied to devices by job accounting software such as SyncThru™ or CounThru™ admin software.

Using Samsung Printer Status (Windows only)

The Samsung Printer Status is a program that monitors and informs you of the machine status.



- The Samsung Printer Status window and its contents shown in this user's guide may differ depending on the machine or operating system in use.
- Check the operating system(s) that are compatible with your machine (see Basic guide).

Samsung Printer Status overview

If an error occurs while operating, you can check the error from the Samsung Printer Status. Samsung Printer Status is installed automatically when you install the machine software.

You can also launch Samsung Printer Status manually. Go to the **Printing Preferences**, click the **Basic** tab > **Printer Status** button.

These icons appear on the Windows task bar:

Icon	Mean	Description
	Normal	The machine is in ready mode and experiencing no errors or warnings.
	Warning	The machine is in a state where an error might occur in the future. For example, it might be in toner low status, which may lead to toner empty status.
	Error	The machine has at least one error.

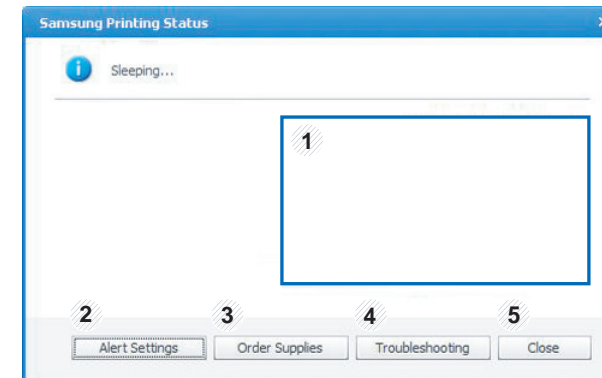

1	Toner Level	You can view the level of toner remaining in each toner cartridge. The machine and the number of toner cartridge(s) shown in the above window may differ depending on the machine in use. Some machines do not have this feature.
---	--------------------	---

2	Alert Settings	Select the settings you want from the options window.
3	Order Supplies	You can order replacement toner cartridge(s) from online.
4	Troubleshooting	You can directly open the troubleshooting section in the user's guide.
5	Close	Close the window.



Using Smart Panel (Macintosh and Linux only)



Smart Panel is a program that monitors and informs you of the machine's status, and allows you to customize the machine's settings. For Macintosh, Smart Panel is installed automatically when you install the machine software. For Linux, you can download Smart Panel from the Samsung website (see "Installing the Smart Panel" on page 8).



- The Smart Panel window and its contents shown in this user's guide may differ depending on the machine or operating system in use.
- Check the operating system(s) that are compatible with your machine (see Basic Guide).



Smart Panel overview

If an error occurs while operating, you can check the error from the Smart Panel. You can also launch Smart Panel manually.

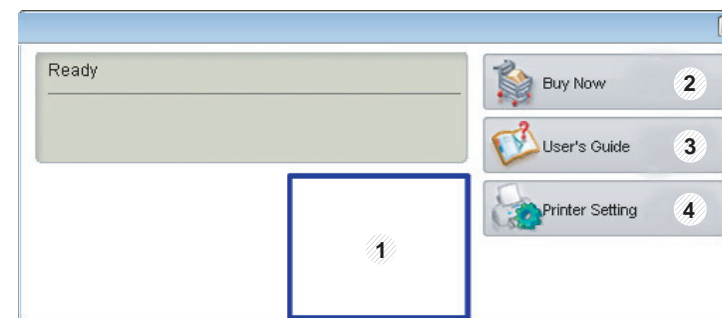
Macintosh		Click this icon the Smart Panel icon on the menu bar.
Linux		Double-click the Smart Panel icon in the Notification Area.



1	Toner Level	You can view the level of toner remaining in each toner cartridge. The machine and the number of toner cartridge(s) shown in the above window may differ depending on the machine in use. Some machines do not have this feature.
2	Buy Now	You can order replacement toner cartridge(s) from online.

3	User's Guide	You can view the online User's Guide.  This button opens the Troubleshooting Guide when an error occurs. You can directly open the troubleshooting section in the user's guide.
4	Printer Setting	You can configure various machine settings in the Printer Settings Utility window. Some machines do not have this feature.  If you connect your machine to a network, the SyncThru™ Web Service window appears instead of the Printer Settings Utility.

Changing Smart Panel 's settings

Right-click in Linux or in Mac OS X click on the Smart Panel icon and select **Options**. Select the settings you want from the **Options** window.



Using the Linux Unified Driver Configurator

The Unified Driver Configurator is a tool primarily intended for configuring machine devices. You need to install Unified Linux Driver to use Unified Driver Configurator (see "Installation for Linux" on page 8).

After the driver is installed on your Linux system, the Unified Driver Configurator icon will automatically be created on your desktop.

Opening Unified Driver Configurator

- 1 Double-click the **Unified Driver Configurator** on the desktop.
You can also click the **Startup** Menu icon and select **Samsung Unified Driver > Unified Driver Configurator**.
- 2 Click each button on the left to switch to the corresponding configuration window.

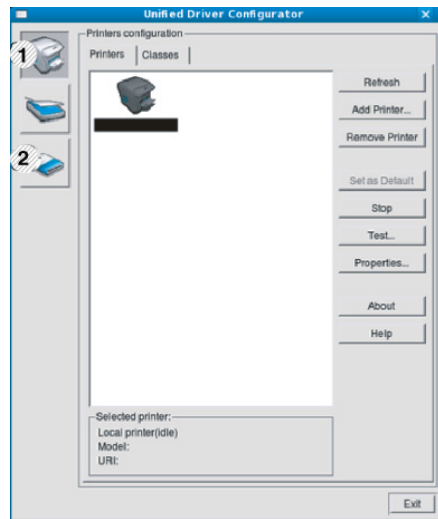

- 1 Printer Configuration
- 2 Port Configuration



To use the on screen help, click **Help**.

- 3 After changing the configurations, click **Exit** to close the **Unified Driver Configurator**.

Printers configuration

Printers configuration has the two tabs: **Printers** and **Classes**.

► Printers tab

View the current system's printer configuration by clicking on the machine icon button on the left side of the **Unified Driver Configurator** window.

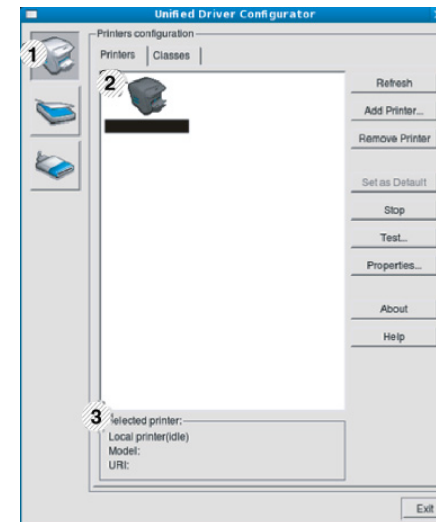

- | | |
|---|--|
| 1 | Switches to Printers configuration . |
| 2 | Shows all of the installed machines. |
| 3 | Shows the status, model name, and URI of your machine. |

The printer control buttons are, as follows:

- **Refresh:** Renews the available machines list.
- **Add Printer:** Allows you to add a new machines.
- **Remove Printer:** Removes the selected machine.

- **Set as Default:** Sets the current selected machine as a default machine.
- **Stop/Start:** Stops/starts the machine.
- **Test:** Allows you to print a test page to ensure the machine is working properly.
- **Properties:** Allows you to view and change the printer's properties.

► Classes tab

The Classes tab shows a list of available machine classes.

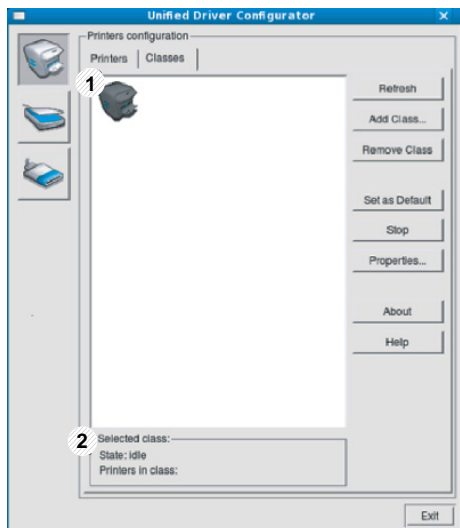

1	Shows all of the machine classes.
2	Shows the status of the class and the number of machines in the class.

- **Refresh:** Renews the classes list.
- **Add Class:** Allows you to add a new machine class.
- **Remove Class:** Removes the selected machine class.

Ports configuration

In this window, you can view the list of available ports, check the status of each port and release a port that is stalled in a busy state when its owner has terminated the job for any reason.

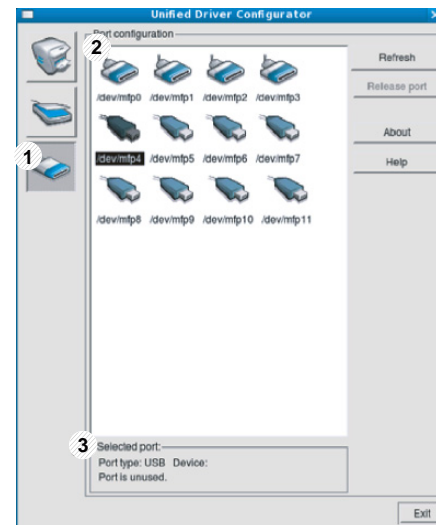

1	Switches to Ports configuration .
2	Shows all of the available ports.
3	Shows the port type, device connected to the port, and status.

- **Refresh:** Renews the available ports list.
- **Release port:** Releases the selected port.

6. Troubleshooting

This chapter gives helpful information for what to do if you encounter an error.

- **Paper feeding problems** 105
- **Power and cable connecting problems** 106
- **Printing problems** 107
- **Printing quality problems** 111
- **Operating system problems** 119



Condition	Suggested solutions
Paper jams during printing.	Clear the paper jam.
Paper sticks together.	<ul style="list-style-type: none">• Check the maximum paper capacity of the tray .• Make sure that you are using the correct type of paper.• Remove paper from the tray and flex or fan the paper.• Humid conditions may cause some paper to stick together.
Multiple sheets of paper do not feed.	Different types of paper may be stacked in the tray. Load paper of only one type, size, and weight.
Paper does not feed into the machine.	<ul style="list-style-type: none">• Remove any obstructions from inside the machine.• Paper has not been loaded correctly. Remove paper from the tray and reload it correctly.• There is too much paper in the tray. Remove excess paper from the tray.• The paper is too thick. Use only paper that meets the specifications required by the machine.
The paper keeps jamming.	<ul style="list-style-type: none">• There is too much paper in the tray. Remove excess paper from the tray. If you are printing on special materials, use the multi-purpose tray (or manual feeder).• An incorrect type of paper is being used. Use only paper that meets the specifications required by the machine.• There may be debris inside the machine. Open the front cover and remove any debris.
Transparencies stick together in the paper exit.	Use only transparencies specifically designed for laser printers. Remove each transparency as it exits from the machine.
Envelopes skew or fail to feed correctly.	Ensure that the paper guides are against both sides of the envelopes.



Click this link to open an animation about solving power problems.

Condition	Suggested solutions
The machine is not receiving power, or the connection cable between the computer and the machine is not connected properly.	<ul style="list-style-type: none">• Connect the machine to the electricity supply first and press the  (Power) button on the control panel.• Disconnect the machine's cable and reconnect it.

Condition	Possible cause	Suggested solutions
The machine does not print.	The machine is not receiving power.	Check the power cord connections. Check the power switch and the power source.
	The machine is not selected as the default machine.	Select your machine as your default machine in Windows.
	Check the machine for the following: <ul style="list-style-type: none">• The front cover is not closed. Close the front cover.• Paper is jammed. Clear the paper jam.• No paper is loaded. Load paper.• The toner cartridge is not installed. Install the toner cartridge. If a system error occurs, contact your service representative.	
	The connection cable between the computer and the machine is not connected properly.	Disconnect the machine cable and reconnect it.
	The connection cable between the computer and the machine is defective.	If possible, attach the cable to another computer that is working properly and print a job. You can also try using a different machine cable.
	The port setting is incorrect.	Check the Windows printer settings to make sure that the print job is sent to the correct port. If the computer has more than one port, make sure that the machine is attached to the correct one.
	The machine may be configured incorrectly.	Check the Printing Preferences to ensure that all of the print settings are correct.

Condition	Possible cause	Suggested solutions
The machine does not print.	The printer driver may be incorrectly installed.	Uninstall and reinstall the machine's driver.
	The machine is malfunctioning.	Check the display message on the control panel to see if the machine is indicating a system error. Contact a service representative.
	The document size is so big that the hard disk space of the computer is insufficient to access the print job.	Get more hard disk space and print the document again.
	The output tray is full.	Once the paper is removed from the output tray, the machine resumes printing.
The machine selects print materials from the wrong paper source.	The paper option that was selected in the Printing Preferences may be incorrect.	For many software applications, the paper source selection is found under the Paper tab within the Printing Preferences . Select the correct paper source. See the printer driver help screen.
A print job is extremely slow.	The job may be very complex.	Reduce the complexity of the page or try adjusting the print quality settings.
Half the page is blank.	The page orientation setting may be incorrect.	Change the page orientation in your application. See the printer driver help screen.
	The paper size and the paper size settings do not match.	Ensure that the paper size in the printer driver settings matches the paper in the tray. Or, ensure that the paper size in the printer driver settings matches the paper selection in the software application settings you use.

Condition	Possible cause	Suggested solutions
The machine prints, but the text is wrong, garbled, or incomplete.	The machine cable is loose or defective.	Disconnect the machine cable and reconnect. Try a print job that you have already printed successfully. If possible, attach the cable and the machine to another computer that you know works and try a print job. Finally, try a new machine cable.
	The wrong printer driver was selected.	Check the application's printer selection menu to ensure that your machine is selected.
	The software application is malfunctioning.	Try printing a job from another application.
	The operating system is malfunctioning.	Exit Windows and reboot the computer. Turn the machine off and back on again.
	If you are in a DOS environment, the font setting for your machine may be set incorrectly.	See "Changing the font setting" on page 68.
Pages print, but they are blank.	The toner cartridge is defective or out of toner.	Redistribute the toner, if necessary. If necessary, replace the toner cartridge.
	The file may have blank pages.	Check the file to ensure that it does not contain blank pages.
	Some parts, such as the controller or the board, may be defective.	Contact a service representative.

Condition	Possible cause	Suggested solutions
The machine does not print PDF files correctly. Some parts of graphics, text, or illustrations are missing.	Incompatibility between the PDF file and the Acrobat products.	Printing the PDF file as an image may enable the file to print. Turn on Print As Image from the Acrobat printing options.  It will take longer to print when you print a PDF file as an image.
The print quality of photos is not good. Images are not clear.	The resolution of the photo is very low.	Reduce the photo size. If you increase the photo size in the software application, the resolution will be reduced.
Before printing, the machine emits vapor near the output tray.	Using damp paper can cause vapor during printing.	This is not a problem. Just keep printing.
The machine does not print special-sized paper, such as billing paper.	Paper size and paper size setting do not match.	Set the correct paper size in the Custom in Paper tab in Printing Preferences .
The printed billing paper is curled.	The paper type setting does not match.	Change the printer option and try again. Go to Printing Preferences , click Paper tab, and set type to Thick .

If the inside of the machine is dirty or paper has been loaded improperly, there might be a reduction in print quality. See the table below to clear the problem.

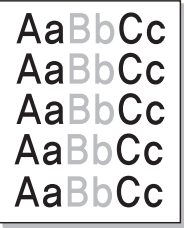
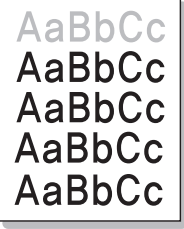
Condition	Suggested Solutions
<p>Light or faded print</p> 	<ul style="list-style-type: none">• If a vertical white streak or faded area appears on the page, the toner supply is low. Install a new toner cartridge.• The paper may not meet paper specifications; for example, the paper may be too moist or rough.• If the entire page is light, the tint is too low or the toner save mode is on. Adjust the print resolution and turn the toner save mode off. See the help screen of the printer driver.• A combination of faded or smeared defects may indicate that the toner cartridge needs cleaning. Clean the inside of your machine.• The surface of the LSU part inside the machine may be dirty. Clean the inside of your machine. If these steps do not correct the problem, contact a service representative.
<p>The top half of the paper is printed lighter than the rest of the paper</p> 	<p>The toner might not adhere properly to this type of paper.</p> <ul style="list-style-type: none">• Change the printer option and try again. Go to Printing Preferences, click the Paper tab, and set the paper type to Recycled.

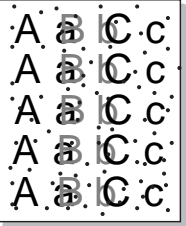
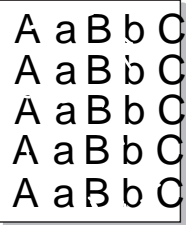
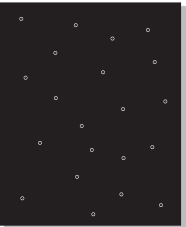
Condition	Suggested Solutions
<p>Toner specks</p> 	<ul style="list-style-type: none"> • The paper may not meet specifications; for example, the paper may be too moist or rough. • The transfer roller may be dirty. Clean the inside of your machine. • The paper path may need cleaning. Contact a service representative.
<p>Dropouts</p> 	<p>If faded areas, generally rounded, occur randomly on the page:</p> <ul style="list-style-type: none"> • A single sheet of paper may be defective. Try reprinting the job. • The moisture content of the paper is uneven or the paper has moist spots on its surface. Try a different brand of paper. • The paper lot is bad. The manufacturing processes can cause some areas to reject toner. Try a different kind or brand of paper. • Change the printer option and try again. Go to Printing Preferences, click the Paper tab, and set type to Thick or Thicker (see Basic Guide for paper weights for each sheet). <p>If these steps do not correct the problem, contact a service representative.</p>
<p>White Spots</p> 	<p>If white spots appear on the page:</p> <ul style="list-style-type: none"> • The paper is too rough and a lot of dirt from paper falls to the inner components within the machine, so the transfer roller may be dirty. Clean the inside of your machine. • The paper path may need cleaning. Clean the inside of your machine. <p>If these steps do not correct the problem, contact a service representative.</p>

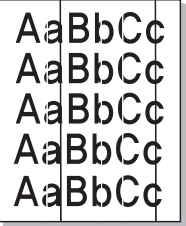
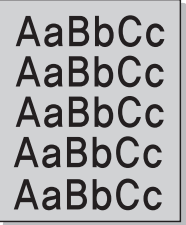
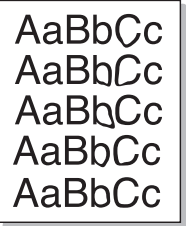
Condition	Suggested Solutions
Vertical lines 	<p>If black vertical streaks appear on the page:</p> <ul style="list-style-type: none">• The surface (drum part) of the toner cartridge inside the machine has probably been scratched. Remove the toner cartridge and install a new one. <p>If white vertical streaks appear on the page:</p> <ul style="list-style-type: none">• The surface of the LSU part inside the machine may be dirty. Clean the inside of your machine. If these steps do not correct the problem, contact a service representative.
Black background 	<p>If the amount of background shading becomes unacceptable:</p> <ul style="list-style-type: none">• Change to a lighter weight paper.• Check the environmental conditions: very dry conditions or a high level of humidity (higher than 80% RH) can increase the amount of background shading.• Remove the old toner cartridge and install a new one.
Toner smear 	<ul style="list-style-type: none">• Clean the inside of the machine.• Check the paper type and quality.• Remove the toner cartridge and install a new one.

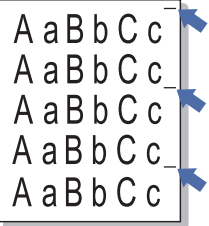
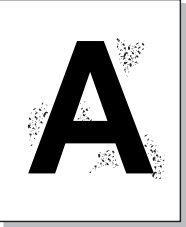
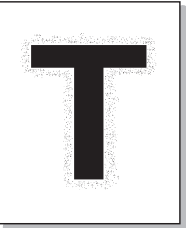
Condition	Suggested Solutions
<p>Vertical repetitive defects</p> 	<p>If marks repeatedly appear on the printed side of the page at even intervals:</p> <ul style="list-style-type: none">• The toner cartridge may be damaged. If you still have the same problem, remove the toner cartridge and, install a new one.• Parts of the machine may have toner on them. If the defects occur on the back of the page, the problem will likely correct itself after a few more pages.• The fusing assembly may be damaged. Contact a service representative.
<p>Background scatter</p> 	<p>Background scatter results from bits of toner randomly distributed on the printed page.</p> <ul style="list-style-type: none">• The paper may be too damp. Try printing with a different batch of paper. Do not open packages of paper until necessary so that the paper does not absorb too much moisture.• If background scatter occurs on an envelope, change the printing layout to avoid printing over areas that have overlapping seams on the reverse side. Printing on seams can cause problems.• If background scatter covers the entire surface area of a printed page, adjust the print resolution through your software application or in Printing Preferences. Ensure the correct paper type is selected. For example: If Thicker Paper is selected, but Plain Paper actually used, an overcharging can occur causing this copy quality problem.
<p>Toner particles are around bold characters or pictures</p> 	<p>The toner might not adhere properly to this type of paper.</p> <ul style="list-style-type: none">• Change the printer option and try again. Go to Printing Preferences, click the Paper tab, and set the paper type to Recycled. Ensure the correct paper type is selected. For example: If Thicker Paper is selected, but Plain Paper actually used, an overcharging can occur causing this copy quality problem.

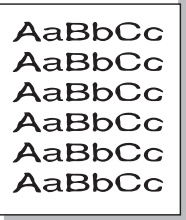
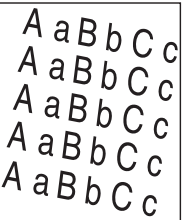
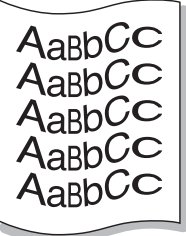
Condition	Suggested Solutions
<p>Misformed characters</p> 	<ul style="list-style-type: none">• If characters are improperly formed and producing hollow images, the paper stock may be too slick. Try different paper.
<p>Page skew</p> 	<ul style="list-style-type: none">• Ensure that the paper is loaded properly.• Check the paper type and quality.• Ensure that the guides are not too tight or too loose against the paper stack.
<p>Curl or wave</p> 	<ul style="list-style-type: none">• Ensure that the paper is loaded properly.• Check the paper type and quality. Both high temperature and humidity can cause paper curl.• Turn the stack of paper over in the tray. Also try rotating the paper 180° in the tray.

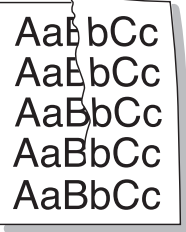
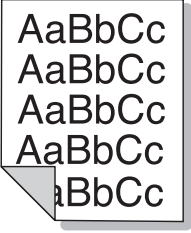
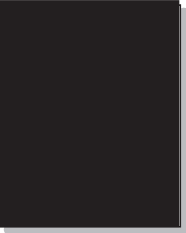
Condition	Suggested Solutions
<p>Wrinkles or creases</p> 	<ul style="list-style-type: none">• Ensure that the paper is loaded properly.• Check the paper type and quality.• Turn the stack of paper over in the tray. Also try rotating the paper 180° in the tray.
<p>Back of printouts are dirty</p> 	<ul style="list-style-type: none">• Check for leaking toner. Clean the inside of the machine.
<p>Solid color or black pages</p> 	<ul style="list-style-type: none">• The toner cartridge may not be installed properly. Remove the cartridge and reinsert it.• The toner cartridge may be defective. Remove the toner cartridge and install a new one.• The machine may require repairing. Contact a service representative.

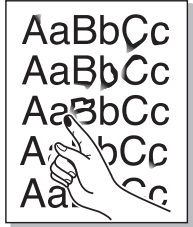
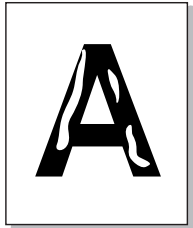
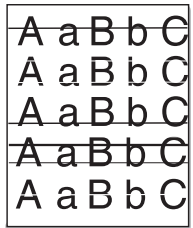
Condition	Suggested Solutions
<p>Loose toner</p> 	<ul style="list-style-type: none">• Clean the inside of the machine.• Check the paper type and quality.• Remove the toner cartridge and then, install a new one. <p>If the problem persists, the machine may require repair. Contact a service representative.</p>
<p>Character voids</p> 	<p>Character voids are white areas within parts of characters that should be solid black:</p> <ul style="list-style-type: none">• If you are using transparencies, try another type of transparency. Because of the composition of transparencies, some character voids are normal.• You may be printing on the wrong surface of the paper. Remove the paper and turn it around.• The paper may not meet paper specifications.
<p>Horizontal stripes</p> 	<p>If horizontally aligned black streaks or smears appear:</p> <ul style="list-style-type: none">• The toner cartridge may be installed improperly. Remove the cartridge and reinsert it.• The toner cartridge may be defective. Remove the toner cartridge and install a new one. <p>If the problem persists, the machine may require repairing. Contact a service representative.</p>

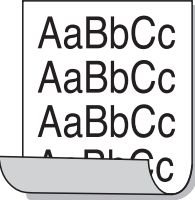
Condition	Suggested Solutions
<p>Curl</p> 	<p>If the printed paper is curled or paper does not feed into the machine:</p> <ul style="list-style-type: none">• Turn the stack of paper over in the tray. Also try rotating the paper 180° in the tray.• Change the printer's paper option and try again. Go to Printing Preferences, click the Paper tab, and set type to Thin.
<ul style="list-style-type: none">• An unknown image repetitively appears on a few sheets• Loose toner• Light print or contamination occurs	<p>Your machine is probably being used at an altitude of 1,000 m (3,281 ft) or above.</p> <p>The high altitude may affect the print quality, such as loose toner or light imaging. Change the altitude setting for your machine (See "Altitude adjustment" on page 67).</p>



Common Windows problems

Condition	Suggested solutions
“File in Use” message appears during installation.	Exit all software applications. Remove all software from the startup group, then restart Windows. Reinstall the printer driver.
“General Protection Fault”, “Exception OE”, “Spool 32”, or “Illegal Operation” messages appear.	Close all other applications, reboot Windows and try printing again.
“Fail To Print”, “A printer timeout error occurred” message appear.	These messages may appear during printing. Just keep waiting until the machine finishes printing. If the message appears in ready mode or after printing has completed, check the connection and/or whether an error has occurred.



Refer to the Microsoft Windows 2000/XP/2003/Vista User's Guide that came with your computer for further information on Windows error messages.



Common Macintosh problems

Condition	Suggested solutions
The machine does not print PDF files correctly. Some parts of graphics, text, or illustrations are missing.	<p>Printing the PDF file as an image may enable the file to print. Turn on Print As Image from the Acrobat printing options.</p> <p> It will take longer to print when you print a PDF file as an image.</p>
The document has printed, but the print job has not disappeared from the spooler in Mac OS X10.3.2.	<p>Update your MAC OS to MAC OS X 10.3.3 or higher.</p>
Some letters are not displayed normally during cover page printing.	<p>Mac OS cannot create the font while printing the cover page. The English alphabet and numbers are displayed normally on the cover page.</p>
When printing a document in Macintosh with Acrobat Reader 6.0 or higher, colors print incorrectly.	<p>Make sure that the resolution setting in your machine driver matches the one in Acrobat Reader.</p>



Refer to the Macintosh User's Guide that came with your computer for further information on Macintosh error messages.



Common Linux problems

Condition	Suggested solutions
The machine does not print.	<ul style="list-style-type: none">• Check if the printer driver is installed in your system. Open Unified Driver Configurator and switch to the Printers tab in the Printers configuration window to look at the list of available machines. Make sure that your machine is displayed on the list. If not, open Add new printer wizard to set up your device.• Check if the machine is started. Open Printers configuration and select your machine from the printers list. Look at the description in the Selected printer pane. If its status contains Stopped, press the Start button. Normal operation of the machine should be restored. The “stopped” status might be activated when some problems in printing occur.• Check if your application has special print options such as “-oraw”. If “-oraw” is specified in the command line parameter, then remove it to print properly. For Gimp front-end, select “print” -> “Setup printer” and edit the command line parameter in the command item.
The machine does not print whole pages, and output is printed on half the page.	<p>It is a known problem that occurs when a color machine is used on version 8.51 or earlier of Ghostscript, 64-bit Linux OS, and has been reported to bugs.ghostscript.com as Ghostscript Bug 688252. The problem is solved in AFPL Ghostscript v. 8.52 or above. Download the latest version of AFPL Ghostscript from http://sourceforge.net/projects/ghostscript/ and install it to solve this problem.</p>
“Cannot open port device file” error message appears when printing a document.	<p>Avoid changing print job parameters (e.g., via LPR GUI) while a print job is in progress. Known versions of CUPS server break the print job whenever print options are changed and then try to restart the job from the beginning. Since Unified Linux Driver locks the port while printing, the abrupt termination of the driver keeps the port locked and unavailable for subsequent print jobs. If this situation occurs, try to release the port by selecting Release port in the Port configuration window.</p>



Refer to the Linux User's Guide that came with your computer for further information on Linux error messages.



Common PostScript problems

The following situations are PS language specific and may occur when several printer languages are used.

Problem	Possible cause	Solution
The PostScript file cannot be printed.	The PostScript driver may not be installed correctly.	<ul style="list-style-type: none">• Install the PostScript driver (see "Software installation" on page 4).• Print a configuration page and verify that the PS version is available for printing.• If the problem persists, contact a service representative.
Limit Check Error report prints.	The print job was too complex.	You might need to reduce the complexity of the page or install more memory.
A PostScript error page prints.	The print job may not be PostScript.	Make sure that the print job is a PostScript job. Check to see whether the software application expected a setup or PostScript header file to be sent to the machine.
The optional tray is not selected in the driver.	The printer driver has not been configured to recognize the optional tray.	Open the PostScript driver properties, select the Device Options tab, and set the tray option.

If you have any comments or questions regarding Samsung products, contact the Samsung customer care center.

Country/Region	Customer Care Center	Web Site
ALBANIA	42 27 5755	
ARGENTINE	0800-333-3733	www.samsung.com
ARMENIA	0-800-05-555	
AUSTRALIA	1300 362 603	www.samsung.com
AUSTRIA	0810-SAMSUNG (7267864, € 0.07/min)	www.samsung.com
AZERBAIJAN	088-55-55-555	
BAHRAIN	8000-4726	www.samsung.com
BELARUS	810-800-500-55-500	
BELGIUM	02-201-24-18	www.samsung.com /be (Dutch) www.samsung.com /be_fr (French)
BOSNIA	05 133 1999	
BRAZIL	0800-124-421 4004-0000	www.samsung.com
BULGARIA	07001 33 11	www.samsung.com

Country/Region	Customer Care Center	Web Site
CANADA	1-800-SAMSUNG (726-7864)	www.samsung.com
CHILE	800-SAMSUNG (726-7864)	www.samsung.com
CHINA	400-810-5858	www.samsung.com
COLOMBIA	01-8000112112	www.samsung.com
COSTA RICA	0-800-507-7267	www.samsung.com
CROATIA	062 SAMSUNG (062 726 7864)	www.samsung.com
CZECH REPUBLIC	800-SAMSUNG (800-726786) Samsung Zrt., česká organizační složka, Oasis Florenc, Sokolovská394/17, 180 00, Praha 8	www.samsung.com
DENMARK	70 70 19 70	www.samsung.com
DOMINICA	1-800-751-2676	www.samsung.com
ECUADOR	1-800-10-7267	www.samsung.com
EGYPT	0800-726786	www.samsung.com
EIRE	0818 717100	www.samsung.com
EL SALVADOR	800-6225	www.samsung.com
ESTONIA	800-7267	www.samsung.com
FINLAND	030-6227 515	www.samsung.com

Country/Region	Customer Care Center	Web Site
FRANCE	01 48 63 00 00	www.samsung.com
GERMANY	01805 - SAMSUNG (726-7864 € 0,14/min)	www.samsung.com
GEORGIA	8-800-555-555	
GREECE	IT and Mobile : 80111-SAMSUNG (80111 7267864) from land line, local charge/ from mobile, 210 6897691 Cameras, Camcorders, Televisions and Household Appliances From mobile and fixed 2106293100	www.samsung.com
GUATEMALA	1-800-299-0013	www.samsung.com
HONDURAS	800-27919267	www.samsung.com
HONG KONG	(852) 3698-4698	www.samsung.com /hk www.samsung.com /hk_en/
HUNGARY	06-80-SAMSUNG (726-7864)	www.samsung.com

Country/Region	Customer Care Center	Web Site
INDIA	3030 8282 1800 3000 8282	www.samsung.com
INDONESIA	0800-112-8888 021-5699-7777	www.samsung.com
IRAN	021-8255	www.samsung.com
ITALY	800-SAMSUNG (726-7864)	www.samsung.com
JAMAICA	1-800-234-7267	www.samsung.com
JAPAN	0120-327-527	www.samsung.com
JORDAN	800-22273	www.samsung.com
KAZAKHSTAN	8-10-800-500-55-500 (GSM:7799)	www.samsung.com
KOSOVO	+381 0113216899	
KUWAIT	183-2255	www.samsung.com
KYRGYZSTAN	00-800-500-55-500	www.samsung.com
LATVIA	8000-7267	www.samsung.com
LITHUANIA	8-800-77777	www.samsung.com
LUXEMBURG	261 03 710	www.samsung.com
MALAYSIA	1800-88-9999	www.samsung.com

Country/Region	Customer Care Center	Web Site
MACEDONIA	023 207 777	
MEXICO	01-800-SAMSUNG (726-7864)	www.samsung.com
MOLDOVA	00-800-500-55-500	
MONTENEGRO	020 405 888	
MOROCCO	080 100 2255	www.samsung.com
NIGERIA	080-SAMSUNG(726-7864)	www.samsung.com
NETHERLANDS	0900-SAMSUNG (0900-7267864) (€ 0,10/min)	www.samsung.com
NEW ZEALAND	0800 SAMSUNG (0800 726 786)	www.samsung.com
NICARAGUA	00-1800-5077267	www.samsung.com
NORWAY	815-56 480	www.samsung.com
OMAN	800-SAMSUNG (726-7864)	www.samsung.com
PANAMA	800-7267	www.samsung.com
PERU	0-800-777-08	www.samsung.com

Country/Region	Customer Care Center	Web Site
PHILIPPINES	1800-10-SAMSUNG (726-7864) 1-800-3-SAMSUNG (726-7864) 1-800-8-SAMSUNG (726-7864) 02-5805777	www.samsung.com
POLAND	0 801 1SAMSUNG (172678) 022-607-93-33	www.samsung.com
PORTUGAL	80820-SAMSUNG (726-7864)	www.samsung.com
PUERTO RICO	1-800-682-3180	www.samsung.com
RUMANIA	08010 SAMSUNG (08010 726 7864) only from landline, local network Romtelecom - local tariff / 021 206 01 10 for landline and mobile, normal tariff.	www.samsung.com
RUSSIA	8-800-555-55-55	www.samsung.com
SAUDI ARABIA	9200-21230	www.samsung.com
SERBIA	0700 SAMSUNG (0700 726 7864)	www.samsung.com

Country/Region	Customer Care Center	Web Site
SINGAPORE	1800-SAMSUNG (726-7864)	www.samsung.com
SLOVAKIA	0800-SAMSUNG (726-7864)	www.samsung.com
SOUTH AFRICA	0860 SAMSUNG (726-7864)	www.samsung.com
SPAIN	902-1-SAMSUNG(902 172 678)	www.samsung.com
SWEDEN	0771 726 7864 (SAMSUNG)	www.samsung.com
SWITZERLAND	0848-SAMSUNG (7267864, CHF 0.08/min)	www.samsung.com /ch www.samsung.com /ch_fr/
TADJIKISTAN	8-10-800-500-55-500	www.samsung.com
TAIWAN	0800-329-999	www.samsung.com
THAILAND	1800-29-3232 02-689-3232	www.samsung.com
TRINIDAD & TOBAGO	1-800-SAMSUNG (726-7864)	www.samsung.com
TURKEY	444 77 11	www.samsung.com
U.A.E	800-SAMSUNG (726-7864)	www.samsung.com
U.K	0330 SAMSUNG (726-7864)	www.samsung.com

Country/Region	Customer Care Center	Web Site
U.S.A	1-800-SAMSUNG (726-7864)	www.samsung.com
UKRAINE	0-800-502-000	www.samsung.com /ua www.samsung.com /ua_ru
UZBEKISTAN	8-10-800-500-55-500	www.samsung.com
VENEZUELA	0-800-100-5303	www.samsung.com
VIETNAM	1 800 588 889	www.samsung.com



The following glossary helps you get familiar with the product by understanding the terminologies commonly used with printing as well as mentioned in this user's guide.

802.11

802.11 is a set of standards for wireless local area network (WLAN) communication, developed by the IEEE LAN/MAN Standards Committee (IEEE 802).

802.11b/g/n

802.11b/g/n can share same hardware and use the 2.4 GHz band. 802.11b supports bandwidth up to 11 Mbps, 802.11n supports bandwidth up to 150 Mbps. 802.11b/g/n devices may occasionally suffer interference from microwave ovens, cordless telephones, and Bluetooth devices.

Access point

Access Point or Wireless Access Point (AP or WAP) is a device that connects wireless communication devices together on wireless local area networks (WLAN), and acts as a central transmitter and receiver of WLAN radio signals.

ADF

An Automatic Document Feeder (ADF) is a scanning unit that will automatically feed an original sheet of paper so that the machine can scan some amount of the paper at once.

AppleTalk

AppleTalk is a proprietary suite of protocols developed by Apple, Inc for computer networking. It was included in the original Macintosh (1984) and is now deprecated by Apple in favor of TCP/IP networking.

BIT Depth

A computer graphics term describing the number of bits used to represent the color of a single pixel in a bitmapped image. Higher color depth gives a broader range of distinct colors. As the number of bits increases, the number of possible colors becomes impractically large for a color map. 1-bit color is commonly called as monochrome or black and white.

BMP

A bitmapped graphics format used internally by the Microsoft Windows graphics subsystem (GDI), and used commonly as a simple graphics file format on that platform.

BOOTP

Bootstrap Protocol. A network protocol used by a network client to obtain its IP address automatically. This is usually done in the bootstrap process of computers or operating systems running on them. The BOOTP servers assign the IP address from a pool of addresses to each client. BOOTP enables 'diskless workstation' computers to obtain an IP address prior to loading any advanced operating system.

CCD

Charge Coupled Device (CCD) is a hardware which enables the scan job. CCD Locking mechanism is also used to hold the CCD module to prevent any damage when you move the machine.

Collation

Collation is a process of printing a multiple-copy job in sets. When collation is selected, the device prints an entire set before printing additional copies.

Control Panel

A control panel is a flat, typically vertical, area where control or monitoring instruments are displayed. They are typically found in front of the machine.

Coverage

It is the printing term used for a toner usage measurement on printing. For example, 5% coverage means that an A4 sided paper has about 5% image or text on it. So, if the paper or original has complicated images or lots of text on it, the coverage will be higher and at the same time, a toner usage will be as much as the coverage.

CSV

Comma Separated Values (CSV). A type of file format, CSV is used to exchange data between disparate applications. The file format, as it is used in Microsoft Excel, has become a de facto standard throughout the industry, even among non-Microsoft platforms.

DADF

A Duplex Automatic Document Feeder (DADF) is a scanning unit that will automatically feed and turn over an original sheet of paper so that the machine can scan on both sides of the paper.

Default

The value or setting that is in effect when taking a printer out of its box state, reset, or initialized.

DHCP

A Dynamic Host Configuration Protocol (DHCP) is a client-server networking protocol. A DHCP server provides configuration parameters specific to the DHCP client host requesting, generally, information required by the client host to participate on an IP network. DHCP also provides a mechanism for allocation of IP addresses to client hosts.

DIMM

Dual Inline Memory Module (DIMM), a small circuit board that holds memory. DIMM stores all the data within the machine like printing data, received fax data.

DLNA

The Digital Living Network Alliance (DLNA) is a standard that allows devices on a home network to share information with each other across the network.

DNS

The Domain Name Server (DNS) is a system that stores information associated with domain names in a distributed database on networks, such as the Internet.

Dot Matrix Printer

A dot matrix printer refers to a type of computer printer with a print head that runs back and forth on the page and prints by impact, striking an ink-soaked cloth ribbon against the paper, much like a typewriter.

DPI

Dots Per Inch (DPI) is a measurement of resolution that is used for scanning and printing. Generally, higher DPI results in a higher resolution, more visible detail in the image, and a larger file size.

DRPD

Distinctive Ring Pattern Detection. Distinctive Ring is a telephone company service which enables a user to use a single telephone line to answer several different telephone numbers.

Duplex

A mechanism that will automatically turn over a sheet of paper so that the machine can print (or scan) on both sides of the paper. A printer equipped with a Duplex Unit can print on both sides of paper during one print cycle.

Duty Cycle

Duty cycle is the page quantity which does not affect printer performance for a month. Generally the printer has the lifespan limitation such as pages per year. The lifespan means the average capacity of print-outs, usually within the warranty period. For example, if the duty cycle is 48,000 pages per month assuming 20 working days, a printer limits 2,400 pages a day.

ECM

Error Correction Mode (ECM) is an optional transmission mode built into Class 1 fax machines or fax modems. It automatically detects and corrects errors in the fax transmission process that are sometimes caused by telephone line noise.

Emulation

Emulation is a technique of one machine obtaining the same results as another.

An emulator duplicates the functions of one system with a different system, so that the second system behaves like the first system. Emulation focuses on exact reproduction of external behavior, which is in contrast to simulation, which concerns an abstract model of the system being simulated, often considering its internal state.

Ethernet

Ethernet is a frame-based computer networking technology for local area networks (LANs). It defines wiring and signaling for the physical layer, and frame formats and protocols for the media access control (MAC)/data link layer of the OSI model. Ethernet is mostly standardized as IEEE 802.3. It has become the most widespread LAN technology in use during the 1990s to the present.

EtherTalk

A suite of protocols developed by Apple Computer for computer networking. It was included in the original Macintosh (1984) and is now deprecated by Apple in favor of TCP/IP networking.

FDI

Foreign Device Interface (FDI) is a card installed inside the machine to allow a third party device such as a coin operated device or a card reader. Those devices allow the pay-for-print service on your machine.

FTP

A File Transfer Protocol (FTP) is a commonly used protocol for exchanging files over any network that supports the TCP/IP protocol (such as the Internet or an intranet).

Fuser Unit

The part of a laser printer that fuses the toner onto the print media. It consists of a heat roller and a pressure roller. After toner is transferred onto the paper, the fuser unit applies heat and pressure to ensure that the toner stays on the paper permanently, which is why paper is warm when it comes out of a laser printer.

Gateway

A connection between computer networks, or between a computer network and a telephone line. It is very popular, as it is a computer or a network that allows access to another computer or network.

Grayscale

A shades of gray that represent light and dark portions of an image when color images are converted to grayscale; colors are represented by various shades of gray.

Halftone

An image type that simulates grayscale by varying the number of dots. Highly colored areas consist of a large number of dots, while lighter areas consist of a smaller number of dots.

HDD

Hard Disk Drive (HDD), commonly referred to as a hard drive or hard disk, is a non-volatile storage device which stores digitally-encoded data on rapidly rotating platters with magnetic surfaces.

IEEE

The Institute of Electrical and Electronics Engineers (IEEE) is an international non-profit, professional organization for the advancement of technology related to electricity.

IEEE 1284

The 1284 parallel port standard was developed by the Institute of Electrical and Electronics Engineers (IEEE). The term "1284-B" refers to a specific connector type on the end of the parallel cable that attaches to the peripheral (for example, a printer).

Intranet

A private network that uses Internet Protocols, network connectivity, and possibly the public telecommunication system to securely share part of an organization's information or operations with its employees. Sometimes the term refers only to the most visible service, the internal website.

IP address

An Internet Protocol (IP) address is a unique number that devices use in order to identify and communicate with each other on a network utilizing the Internet Protocol standard.

IPM

The Images Per Minute (IPM) is a way of measuring the speed of a printer. An IPM rate indicates the number of single-sided sheets a printer can complete within one minute.

IPP

The Internet Printing Protocol (IPP) defines a standard protocol for printing as well as managing print jobs, media size, resolution, and so forth. IPP can be used locally or over the Internet to hundreds of printers, and also supports access control, authentication, and encryption, making it a much more capable and secure printing solution than older ones.

IPX/SPX

IPX/SPX stands for Internet Packet Exchange/Sequenced Packet Exchange. It is a networking protocol used by the Novell NetWare operating systems. IPX and SPX both provide connection services similar to TCP/IP, with the IPX protocol having similarities to IP, and SPX having similarities to TCP. IPX/SPX was primarily designed for local area networks (LANs), and is a very efficient protocol for this purpose (typically its performance exceeds that of TCP/IP on a LAN).

ISO

The International Organization for Standardization (ISO) is an international standard-setting body composed of representatives from national standards bodies. It produces world-wide industrial and commercial standards.

ITU-T

The International Telecommunication Union is an international organization established to standardize and regulate international radio and telecommunications. Its main tasks include standardization, allocation of the radio spectrum, and organizing interconnection arrangements between different countries to allow international phone calls. A -T out of ITU-T indicates telecommunication.

ITU-T No. 1 chart

Standardized test chart published by ITU-T for document facsimile transmissions.

JBIG

Joint Bi-level Image Experts Group (JBIG) is an image compression standard with no loss of accuracy or quality, which was designed for compression of binary images, particularly for faxes, but can also be used on other images.

JPEG

Joint Photographic Experts Group (JPEG) is a most commonly used standard method of lossy compression for photographic images. It is the format used for storing and transmitting photographs on the World Wide Web.

LDAP

The Lightweight Directory Access Protocol (LDAP) is a networking protocol for querying and modifying directory services running over TCP/IP.

LED

A Light-Emitting Diode (LED) is a semiconductor device that indicates the status of a machine.

MAC address

Media Access Control (MAC) address is a unique identifier associated with a network adapter. MAC address is a unique 48-bit identifier usually written as 12 hexadecimal characters grouped in pairs (e. g., 00-00-0c-34-11-4e). This address is usually hard-coded into a Network Interface Card (NIC) by its manufacturer, and used as an aid for routers trying to locate machines on large networks.

MFP

Multi Function Peripheral (MFP) is an office machine that includes the following functionality in one physical body, so as to have a printer, a copier, a fax, a scanner and etc.

MH

Modified Huffman (MH) is a compression method for decreasing the amount of data that needs to be transmitted between the fax machines to transfer the image recommended by ITU-T T.4. MH is a codebook-based run-length encoding scheme optimized to efficiently compress white space. As most faxes consist mostly of white space, this minimizes the transmission time of most faxes.

MMR

Modified Modified READ (MMR) is a compression method recommended by ITU-T T.6.

Modem

A device that modulates a carrier signal to encode digital information, and also demodulates such a carrier signal to decode transmitted information.

MR

Modified Read (MR) is a compression method recommended by ITU-T T.4. MR encodes the first scanned line using MH. The next line is compared to the first, the differences determined, and then the differences are encoded and transmitted.

NetWare

A network operating system developed by Novell, Inc. It initially used cooperative multitasking to run various services on a PC, and the network protocols were based on the archetypal Xerox XNS stack. Today NetWare supports TCP/IP as well as IPX/SPX.

OPC

Organic Photo Conductor (OPC) is a mechanism that makes a virtual image for print using a laser beam emitted from a laser printer, and it is usually green or rust colored and has a cylinder shape.

An imaging unit containing a drum slowly wears the drum surface by its usage in the printer, and it should be replaced appropriately since it gets worn from contact with the cartridge development brush, cleaning mechanism, and paper.

Originals

The first example of something, such as a document, photograph or text, etc, which is copied, reproduced or translated to produce others, but which is not itself copied or derived from something else.

OSI

Open Systems Interconnection (OSI) is a model developed by the International Organization for Standardization (ISO) for communications. OSI offers a standard, modular approach to network design that divides the required set of complex functions into manageable, self-contained, functional layers. The layers are, from top to bottom, Application, Presentation, Session, Transport, Network, Data Link and Physical.

PABX

A private automatic branch exchange (PABX) is an automatic telephone switching system within a private enterprise.

PCL

Printer Command Language (PCL) is a Page Description Language (PDL) developed by HP as a printer protocol and has become an industry standard. Originally developed for early inkjet printers, PCL has been released in varying levels for thermal, dot matrix printer, and laser printers.

PDF

Portable Document Format (PDF) is a proprietary file format developed by Adobe Systems for representing two dimensional documents in a device independent and resolution independent format.

PostScript

PostScript (PS) is a page description language and programming language used primarily in the electronic and desktop publishing areas. - that is run in an interpreter to generate an image.

Printer Driver

A program used to send commands and transfer data from the computer to the printer.

Print Media

The media like paper, envelopes, labels, and transparencies which can be used in a printer, a scanner, a fax or, a copier.

PPM

Pages Per Minute (PPM) is a method of measurement for determining how fast a printer works, meaning the number of pages a printer can produce in one minute.

PRN file

An interface for a device driver, this allows software to interact with the device driver using standard input/output system calls, which simplifies many tasks.

Protocol

A convention or standard that controls or enables the connection, communication, and data transfer between two computing endpoints.

PS

See PostScript.

PSTN

The Public-Switched Telephone Network (PSTN) is the network of the world's public circuit-switched telephone networks which, on industrial premises, is usually routed through the switchboard.

RADIUS

Remote Authentication Dial In User Service (RADIUS) is a protocol for remote user authentication and accounting. RADIUS enables centralized management of authentication data such as usernames and passwords using an AAA (authentication, authorization, and accounting) concept to manage network access.

Resolution

The sharpness of an image, measured in Dots Per Inch (DPI). The higher the dpi, the greater the resolution.

SMB

Server Message Block (SMB) is a network protocol mainly applied to share files, printers, serial ports, and miscellaneous communications between nodes on a network. It also provides an authenticated Inter-process communication mechanism.

SMTP

Simple Mail Transfer Protocol (SMTP) is the standard for e-mail transmissions across the Internet. SMTP is a relatively simple, text-based protocol, where one or more recipients of a message are specified, and then the message text is transferred. It is a client-server protocol, where the client transmits an email message to the server.

SSID

Service Set Identifier (SSID) is a name of a wireless local area network (WLAN). All wireless devices in a WLAN use the same SSID in order to communicate with each other. The SSIDs are case-sensitive and have a maximum length of 32 characters.

Subnet Mask

The subnet mask is used in conjunction with the network address to determine which part of the address is the network address and which part is the host address.

TCP/IP

The Transmission Control Protocol (TCP) and the Internet Protocol (IP); the set of communications protocols that implement the protocol stack on which the Internet and most commercial networks run.

TCR

Transmission Confirmation Report (TCR) provides details of each transmission such as job status, transmission result and number of pages sent. This report can be set to print after each job or only after failed transmissions.

TIFF

Tagged Image File Format (TIFF) is a variable-resolution bitmapped image format. TIFF describes image data that typically come from scanners. TIFF images make use of tags, keywords defining the characteristics of the image that is included in the file. This flexible and platform-independent format can be used for pictures that have been made by various image processing applications.

Toner Cartridge

A kind of bottle or container used in a machine like a printer which contains toner. Toner is a powder used in laser printers and photocopiers, which forms the text and images on the printed paper. Toner can be fused by a combination of heat/pressure from the fuser, causing it to bind to the fibers in the paper.

TWAIN

An industry standard for scanners and software. By using a TWAIN-compliant scanner with a TWAIN-compliant program, a scan can be initiated from within the program. It is an image capture API for Microsoft Windows and Apple Macintosh operating systems.

UNC Path

Uniform Naming Convention (UNC) is a standard way to access network shares in Window NT and other Microsoft products. The format of a UNC path is: \\<servername>\<sharename>\<Additional directory>

URL

Uniform Resource Locator (URL) is the global address of documents and resources on the Internet. The first part of the address indicates what protocol to use, the second part specifies the IP address or the domain name where the resource is located.

USB

Universal Serial Bus (USB) is a standard that was developed by the USB Implementers Forum, Inc., to connect computers and peripherals. Unlike the parallel port, USB is designed to concurrently connect a single computer USB port to multiple peripherals.

Watermark

A watermark is a recognizable image or pattern in paper that appears lighter when viewed by transmitted light. Watermarks were first introduced in Bologna, Italy in 1282; they have been used by papermakers to identify their product, and also on postage stamps, currency, and other government documents to discourage counterfeiting.

WEP

Wired Equivalent Privacy (WEP) is a security protocol specified in IEEE 802.11 to provide the same level of security as that of a wired LAN. WEP provides security by encrypting data over radio so that it is protected as it is transmitted from one end point to another.

WIA

Windows Imaging Architecture (WIA) is an imaging architecture that is originally introduced in Windows Me and Windows XP. A scan can be initiated from within these operating systems by using a WIA-compliant scanner.

WPA

Wi-Fi Protected Access (WPA) is a class of systems to secure wireless (Wi-Fi) computer networks, which was created to improve upon the security features of WEP.

WPA-PSK

WPA-PSK (WPA Pre-Shared Key) is special mode of WPA for small business or home users. A shared key, or password, is configured in the wireless access point (WAP) and any wireless laptop or desktop devices. WPA-PSK generates a unique key for each session between a wireless client and the associated WAP for more advanced security.

WPS

The Wi-Fi Protected Setup (WPS) is a standard for establishing a wireless home network. If your wireless access point supports WPS, you can configure the wireless network connection easily without a computer.

XPS

XML Paper Specification (XPS) is a specification for a Page Description Language (PDL) and a new document format, which has benefits for portable document and electronic document, developed by Microsoft. It is an XML-based specification, based on a new print path and a vector-based device-independent document format.

C

Changing 68

D

direct printing utility 79

driver installation

 Unix 21

F

features

 machine features 55

font setting 68

G

general settings 57, 58, 59, 60, 63

glossary 127

L

LCD display

 browsing the machine status 56

Linux

 common Linux problems 121

 driver installation for network connected 20

 driver installation for USB cable connected
 8

 driver reinstallation for USB cable connected
 10

 printer properties 86

 printing 85

 unified driver configurator 100

 using SetIP 15

M

machine information 56

machine setup

 machine status 56

Macintosh

 common Macintosh problems 120

 driver installation for network connected 18

 driver installation for USB cable connected
 5

 driver reinstallation for USB cable connected
 7

 printing 83

 using SetIP 14

N

network

 driver installation

 Linux 20

 Macintosh 18

 UNIX 21

 Windows 17

 general setup 64

 introducing network programs 12

 IPv6 configuration 24

 SetIP program 13, 14, 15, 49

N-up printing

 Macintosh 83

O

overlay printing

 create 76

 delete 77

 print 77

P

placing a machine

 adjusting the altitude 67

PostScript driver

 troubleshooting 122

print resolution set

 Linux 85

printer preferences

 Linux 86

Printer Status

 general information 98, 99

printing				
changing the default print settings	69			
Linux	85			
Macintosh	83			
multiple pages on one sheet of paper				
Macintosh	83			
printing on both sides of paper				
Macintosh	84			
printing to a file	71			
UNIX	87			
using direct printing utility	79			
printing a document				
Linux	85			
Macintosh	83			
UNIX	87			
problems				
paper feeding problems	105			
power problems	106			
printing problems	107			
printing quality problems	111			
R				
reports				
machine information	56, 60			
		S		
		service contact numbers	123	
		SetIP program	13, 49	
		special print features	66	
		supplies		
		estimated toner cartridge life	91	
		SyncThru Web Service		
		general information	93	
		T		
		toner cartridge		
		estimated life	91	
		handling instructions	90	
		non-Samsung and refilled	90	
		storing	90	
		U		
		UNIX		
		driver installation for network connected	21	
		printing	87	
		USB cable		
		driver installation	5, 8	
		driver reinstallation	7, 10	
		using help	84	
		W		
		watermark		
		create	75	
		delete	75	
		edit	75	
		Windows		
		common Windows problems	119	
		driver installation for network connected	17	
		using SetIP	13, 49	
		wireless		
		ad hoc mode	27	
		computer	28	
		control panel	27	
		Infrastructure mode	27	
		installation	27	
		USB cable	34	
		WPS		
		disconnecting	30	
		PBC mode	29	
		WPS (the machine does not have a display screen)		
		PBC	30	
		PIN	31	
		wireless network		
		network cable	48	